

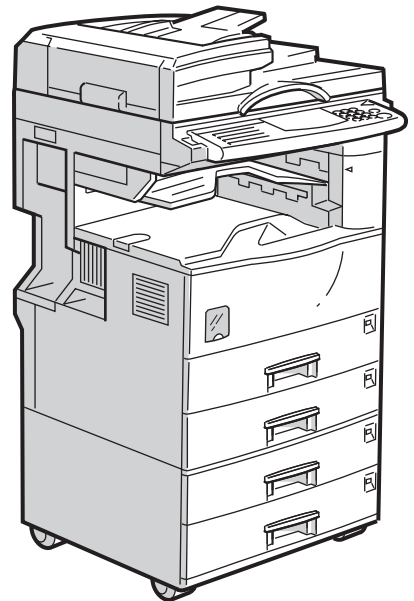

# PRINTER Controller Type 270

## OPERATING INSTRUCTIONS PRINTER REFERENCE (option)



Read this manual carefully before you use this product and keep it handy for future reference.

For safety, please follow the instructions in this manual.

## **Introduction**

This manual contains detailed instructions on the operation and maintenance of this machine. To get maximum versatility from this machine all operators should carefully read and follow the instructions in this manual.

Please keep this manual in a handy place near the machine.

Please read the Safety Information in the "Copy Reference" before using this machine. It contains important information related to USER SAFETY and PREVENTING EQUIPMENT PROBLEMS.

## **Important**

Parts of this manual are subject to change without prior notice. In no event will the company be liable for direct, indirect, special, incidental, or consequential damages as a result of handling or operating the machine.

## **Trademarks**

Microsoft®, Windows®, and MS-DOS® are registered trademarks of Microsoft Corporation in the United States and/or other countries.

Ethernet® is a registered trademark of Xerox Corporation.

PostScript®, Acrobat® are a registered trademark of Adobe System Incorporated.

PCL® is a registered trademark of Hewlett-Packard Company.

Other product names used herein are for identification purposes only and might be trademarks of their respective companies. We disclaim any and all rights in those marks.

IPS-PRINT™ Printer Language Emulation® Copyright 1988 - 1999, XIONICS DOCUMENT TECHNOLOGIES, INC., All Rights Reserved.

## **Warning:**

Use of controls or adjustment or performance of procedures other than those specified in this manual might result in hazardous radiation exposure.

## **Notes:**

Some illustrations might be slightly different from your machine.

Certain options might not be available in some countries. For details, please contact your local dealer.

# How to Read this Manual

---

## Symbols

---

In this manual, the following symbols are used:

 **WARNING:**

This symbol indicates a potentially hazardous situation which, if instructions are not followed, could result in death or serious injury.

 **CAUTION:**

This symbol indicates a potentially hazardous situation which, if instructions are not followed, may result in minor or moderate injury or damage to property.

\* The statements above are notes for your safety.

 **Important**

If this instruction is not followed, paper might be misfed, originals might be damaged, or data might be lost. Be sure to read this.

 **Preparation**

This symbol indicates the prior knowledge or preparations required before operating.

 **Note**

This symbol indicates precautions for operation, or actions to take after misoperation.

 **Limitation**

This symbol indicates numerical limits, functions that cannot be used together, or conditions in which a particular function cannot be used.

 **Reference**

This symbol indicates a reference.

[   ]

Keys that appear on the machine's panel display.

Keys and buttons that appear on the computer's display.

【   】

Keys built into the machine's operation panel.

Keys on the computer's keyboard.

# TABLE OF CONTENTS

## 1. Getting Acquainted

---

<b>Connecting the Machine</b> .....	<b>1</b>
Requirements .....	1
Connecting the Machine to the Host Using the Parallel Interface Cable .....	3
Connecting the Machine Using the Network Interface Board 185 .....	3
<b>Features of this Machine</b> .....	<b>5</b>
Printer Drivers for this Machine .....	6
<b>Guide to this Machine</b> .....	<b>8</b>
Operation Panel .....	8
Panel Display .....	9
Basic Key Operations .....	9
Online and Offline .....	10

## 2. Configuring the Printer for the Network with the Operation Panel

---

<b>Configuring the Printer for the Network with the Operation Panel</b> .....	<b>11</b>
---	-----------

## 3. Installing the Printer Driver and Software

---

<b>Auto Run</b> .....	<b>17</b>
Installing by Auto Run .....	18
<b>Software and Utilities Included on the CD-ROM</b> .....	<b>19</b>
<b>Installing the PCL 6/5e Printer Driver</b> .....	<b>20</b>
Windows 95/98 - Installing the PCL 6/5e Printer Driver .....	20
Windows NT 4.0 - Installing the PCL 6/5e Printer Driver .....	20
Windows 3.1x - Installing the PCL 6/5e Printer Driver .....	21
<b>Installing the PostScript Printer Driver</b> .....	<b>23</b>
Windows 95/98 - Installing the PostScript Printer Driver.....	23
Windows NT 4.0 - Installing the PostScript Printer Driver.....	23
Windows 3.1x - Installing the PostScript Printer Driver .....	24
<b>Using Adobe PageMaker Version 6.0 or 6.5</b> .....	<b>26</b>
<b>Macintosh</b> .....	<b>27</b>
Macintosh - Installing the PostScript Printer Driver .....	27
Setting Up the PPD File .....	28
Setting Up Options .....	28

## 4. Uninstalling the Printer Driver and Software

---

<b>Uninstalling the PCL 6/5e Printer Driver</b> .....	<b>29</b>
Windows 95/98 - Uninstalling the PCL 6/5e Printer Driver.....	29
Windows NT 4.0 - Uninstalling the PCL 6/5e Printer Driver.....	29
Windows 3.1x - Uninstalling the PCL 6/5e Printer Driver.....	30

<b>Uninstalling the PostScript Printer Driver.....</b>	<b>31</b>
Windows 95/98 - Uninstalling the PostScript Printer Driver .....	31
Windows NT 4.0 - Uninstalling the PostScript Printer Driver .....	31
Windows 3.1x - Uninstalling the PostScript Printer Driver .....	32
Macintosh - Uninstalling the PostScript Printer Driver .....	32

## **5. Setting Up the Printer Driver and Canceling a Print Job**

---

<b>PCL 6/5e - Accessing the Printer Properties .....</b>	<b>33</b>
Windows 95/98 - Accessing the Printer Properties .....	33
Windows NT 4.0 - Accessing the Printer Properties .....	34
Windows 3.1x - Accessing the Printer Setting Dialog Box .....	35
<b>PostScript - Setting Up for Printing .....</b>	<b>37</b>
Windows 95/98 - Accessing the Printer Properties .....	37
Windows NT 4.0 - Accessing the Printer Properties .....	38
Windows 3.1x - Accessing the Printer Setting Dialog Box .....	39
Macintosh - Setting Up for Printing .....	40
<b>Canceling a Print Job.....</b>	<b>42</b>
Windows 95/98 - Canceling a Print Job .....	42
Windows NT 4.0 - Canceling a Print Job .....	42
Windows 3.1x - Canceling a Print Job .....	43
Macintosh - Canceling a Print Job .....	44

## **6. Troubleshooting**

---

<b>Error and Status Messages on the Operation Panel.....</b>	<b>45</b>
Error and Status Messages on the Operation Panel.....	45
Getting Printer Information over the Network.....	49
<b>Printer Doesn't Print.....</b>	<b>56</b>
<b>Other Printing Problems .....</b>	<b>60</b>

## **7. Using the Operation Panel**

---

<b>Adjusting Printer Features .....</b>	<b>62</b>
Printer Features Menu .....	62
<b>Accessing the Main Menu.....</b>	<b>64</b>
<b>Making Printer Settings with the Operation Panel .....</b>	<b>65</b>
<b>Proof Print Menu.....</b>	<b>66</b>
Proof Print Parameters.....	66
<b>Job Control Menu .....</b>	<b>67</b>
Job Control Parameters .....	67
<b>Network Setup Menu.....</b>	<b>71</b>
<b>Maintenance Menu .....</b>	<b>72</b>
Maintenance Parameters .....	72
<b>List Print Menu.....</b>	<b>73</b>
List Print Parameters.....	73

<b>Specifying the Custom Paper Size for the Bypass Tray</b> .....	<b>74</b>
<b>Printer Condition</b> .....	<b>75</b>
<b>Printing with the Operation Panel</b> .....	<b>76</b>
Using the Proof Print .....	76

## **8. Appendix**

---

<b>Memory Capacity and Printer Function</b> .....	<b>79</b>
<b>Moving and Transporting the Printer</b> .....	<b>80</b>
<b>Specifications</b> .....	<b>81</b>
<b>INDEX</b> .....	<b>82</b>

# 1. Getting Acquainted

## Connecting the Machine

Confirm that the shape and the position of the connector are as shown in the illustration.

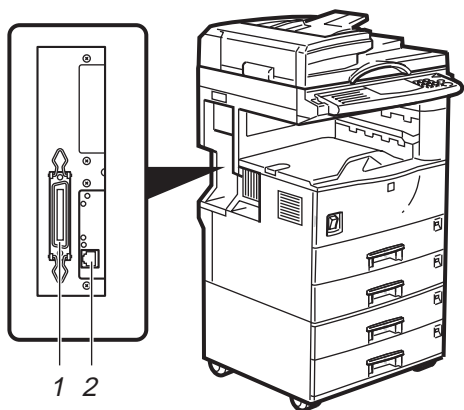

1. Parallel Port

2. 10BASE-T/100BASE-TX (option)

---

## Requirements

---

### Requirements

---

Before using this machine, confirm that all the environmental and electrical requirements have been met. Connect the machine to your host computer using the parallel port, optional Network Interface Board 185, or both.

Confirm that all the cables, connectors, and electrical outlets necessary to attach the machine to your host computer or network are present.

### Important

- The interface cable is not supplied in the box. It is your responsibility to provide the interface cable appropriate for the computer that you are using.

### Reference

For more information on using the parallel port, see P.3 *“Connecting the Machine to the Host Using the Parallel Interface Cable”*.

For more information on using a network, see P.2 *“Network Cable Requirements”*.

### Parallel Cable Requirements

Connect the machine to your host computer using a parallel port. This machine does not provide the parallel cable to connect the machine to the host computer. The machine's parallel interface is a standard bi-directional interface. It requires a standard 36-pin parallel cable compliant with IEEE 1284 and a parallel port available on the host computer.

 **Note**

- Do not use a parallel cable that is longer than 3 meters (10 feet).

### Network Cable Requirements

The optional Network Interface Board 185 can be installed to allow direct connection to an Ethernet network.

The Network Interface Board supports 10BASE-T or 100BASE-TX connections. You can use the machine in the following network environments:

- Using the appropriate network management software and printer driver.
- Attaching the machine to a networked computer set up as a server.

<b>Client</b>	Windows 95, 98, NT 4.0 <sup>*1</sup> , 3.1x, Macintosh (optional PostScript 3 Kit Type 185 is required )
<b>Driver</b>	PCL 6/5e , PostScript 3
<b>File Server</b>	NetWare 3.x, NetWare 4.x, NetWare 5
<b>Protocol</b>	TCP/IP, IPX/SPX, NetBEUI <sup>*2</sup> , AppleTalk

<sup>\*1</sup> With the Windows NT4.0 by the computer based x86 only.

<sup>\*2</sup> Under the Windows 95/98/NT 4.0 only.

In a mixed network environment, the protocol switches automatically.

 **Reference**

For more information on installing the Network Interface Board 185, see the "Operating Instructions" that comes with it.

For more information on resolving network connection problems, see P.11 "Configuring the Printer for the Network with the Operation Panel".

 **Note**

- Consult your network administrator before connecting your machine to a network.
- In a 100BASE-TX environment, be sure to use properly shielded and grounded cable (STP, Category/Type5) for the connection to your host computer (and/or HUB) in order to meet FCC and EMC Directive 89/336/EEC emission guidelines.



---

## Connecting the Machine to the Host Using the Parallel Interface Cable

---

Connect the machine to the host computer using a parallel interface cable compliant with IEEE 1284 (supplied by you).

Follow these steps to connect the machine to your host computer.

- 1** Confirm that you have the correct cable.
- 2** Confirm that both the machine and the host computer are turned off.
- 3** Plug the 36-pin end of the parallel cable into the parallel port at the right side of the back cover of the machine.

### Reference

See P.1 “Connecting the Machine” to confirm of the position of the parallel port.

- 4** Squeeze the wire clips on each side of the connector together until they snap into place. The clips hold the cable securely in place.
- 5** Plug the other end of the parallel cable into the computer's parallel port.

---

## Connecting the Machine Using the Network Interface Board 185

---

Connect the machine to the network using the Network Interface Board 185.

Follow these steps to connect the machine.

- 1** Confirm that you have the correct cable.
- 2** Confirm that the machine is turned off.
- 3** Loop the network cable. The loop should be about 10cm (4”) from the end of the cable on the end closest to the printer.
- 4** Attach the ferrite core to the loop.

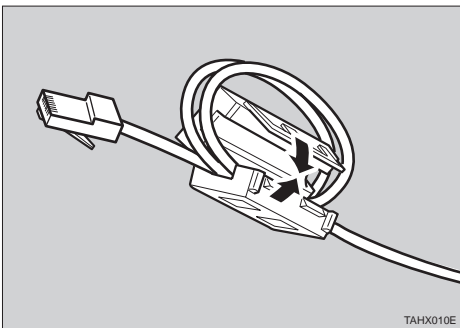

**5** Attach the network cable to the 10BASE-T/100BASE-TX port on the machine.

**Reference**

See P.1 “Connecting the Machine” to confirm of the position of the 10BASE-T/100BASE-TX port.

**Note**

- Confirm that the cable is connected to the 10BASE-T/100BASE-TX port.
- Do not connect the cable into the fax port.

**6** Connect the other end of the cable into the network.

---

**Button and Indicators on the Network Interface Board**

---

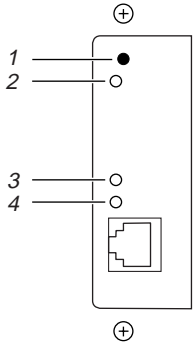

**1. Button**

Press this button for more than 2 seconds to print “Network Configuration Page”. Press this button more than 5 seconds to print “System Log Information”.

**2. Indicator (orange)**

Stays on while the network interface board is working.

**3. Indicator (green)**

Stays on while 100BASE-TX is working. Stays off while 10BASE-T is working.

**4. Indicator (green)**

Stays on while the machine is in a network environment.

# Features of this Machine

This printer is designed especially for office workgroups, both for shared usage within network environment, and for one-to-one usage by being connected directly to your computer.

1

## ❖ High Productivity

As this printer comes with a 27 pages per minute (ppm) engine and offers a variety of paper handling options, handling documents will be more efficient. Proof print function <sup>\*1</sup> is one of the supporting feature for making multiple original printing which allows you to confirm that the document prints as expected before printing many.

<sup>\*1</sup> Optional Printer Hard Disk Type 185 is required.

## ❖ Versatile Paper Handling Options

This printer offers both versatile input and output paper handling options. Input capacity can be raised to 3,100 with the optional paper bank (PS420) and the bypass tray (Bypass Tray Type 270) to reduce the inconvenience of reloading paper. For an output device, collating <sup>\*1</sup> and stapling capability is available with the optional finisher (SR720).

<sup>\*1</sup> Optional Printer Feature Expander Type 185 (32MB or 64MB) or Printer Hard Disk Type 185 is required.

## ❖ Variety of Paper Media Support

Standard Tray 2 and optional Bypass Tray Type 270 support variety of paper media such as thick paper <sup>\*1</sup>, transparency and some envelopes <sup>\*1</sup>.

<sup>\*1</sup> For more information on supported paper and other media, see "Copy Reference".

## ❖ Network Connectivity

Your printer is network ready with the optional network interface board.

## ❖ Network utility

PRINTER MANAGER <sup>\*1</sup>, software consisting of Administration and Client versions, is provided. With this software, multiple print devices can be utilized effectively together on a network. This software offers several convenient functions such as parallel printing and recovery printing.

<sup>\*1</sup> For the name of the PRINTER MANAGER you use, see the "Operating Instructions" for the Network Interface Board which is included in the CD-ROM.

## ❖ Major Specifications

Printing Speed	22/27ppm <sup>*1</sup> (A4 □, 8 1/2" × 11" □, simplex) 22ppm (A4 □, 8 1/2" × 11" □, duplex)
Engine Resolution	600dpi / 300dpi resolution Enhanced resolution with edge smoothing
Printer Language	PCL 5e, PCL 6 Adobe PostScript Level 3 <sup>*2</sup>
Memory	16MB Max. up to 80MB
Interface	10BASE-T or 100BASE-TX <sup>*2</sup> × 1 IEEE1284 × 1

<sup>\*1</sup> Printing speed depends on machine

<sup>\*2</sup> Option

## Printer Drivers for this Machine

Printing requires installation of a printer driver for your operating system. The following drivers are included in the CD-ROM that comes with this machine.

Operating system	Printer Language	PCL 5e	PCL 6	PostScript 3
Windows 95 <sup>*1</sup>		√	√	√
Windows 98 <sup>*2</sup>		√	√	√
Windows 3.1x <sup>*3</sup>		√	√	√
Windows NT 4.0 <sup>*4</sup>		√	√	√ <sup>*6</sup> <sup>*7</sup>
Macintosh <sup>*5</sup>				√ <sup>*7</sup>

<sup>\*1</sup> Microsoft Windows 95 operating system

<sup>\*2</sup> Microsoft Windows 98 operating system

<sup>\*3</sup> Microsoft Windows for Workgroups operating system Version 3.1/3.11

<sup>\*4</sup> Microsoft Windows NT Server network operating system Version 4.0, Microsoft Windows NT Workstation operating system Version 4.0 in a computer using a × 86 processor

<sup>\*5</sup> Required system is 7.1 or later operating system.

<sup>\*6</sup> Requires Service Pack 3 or later.

<sup>\*7</sup> The Adobe PostScript printer drivers and PostScript Printer Description (PPD) files are included in the CD-ROM.

**❖ PCL Printer Drivers**

Printer drivers allow the computer to communicate with the printer via a printer language. Two kinds of PCL printer drivers, PCL 6 and PCL 5e, are included in the CD-ROM that comes with this machine. We recommend the PCL 6 as your first choice. However, some of your applications might require the installation of the PCL 5e printer driver. In this case, you might configure to install and print by using PCL 5e in addition to the PCL 6.

⇒ P.20 *“Windows 95/98 - Installing the PCL 6/5e Printer Driver”*

⇒ P.20 *“Windows NT 4.0 - Installing the PCL 6/5e Printer Driver”*

⇒ P.21 *“Windows 3.1x - Installing the PCL 6/5e Printer Driver”*

**❖ Adobe PostScript Printer Drivers and PPD files**

The Adobe PostScript printer drivers and the PPD files are included in the CD-ROM that comes with this machine. Adobe PostScript printer driver allows the computer to communicate with the printer via a printer language. The PPD files allow the printer driver to enable the printer specific functions.

⇒ P.23 *“Windows 95/98 - Installing the PostScript Printer Driver”*

⇒ P.23 *“Windows NT 4.0 - Installing the PostScript Printer Driver”*

⇒ P.24 *“Windows 3.1x - Installing the PostScript Printer Driver”*

⇒ P.27 *“Macintosh - Installing the PostScript Printer Driver”*

# Guide to this Machine

1

## Operation Panel

This panel display is for installed Facsimile and Printer.

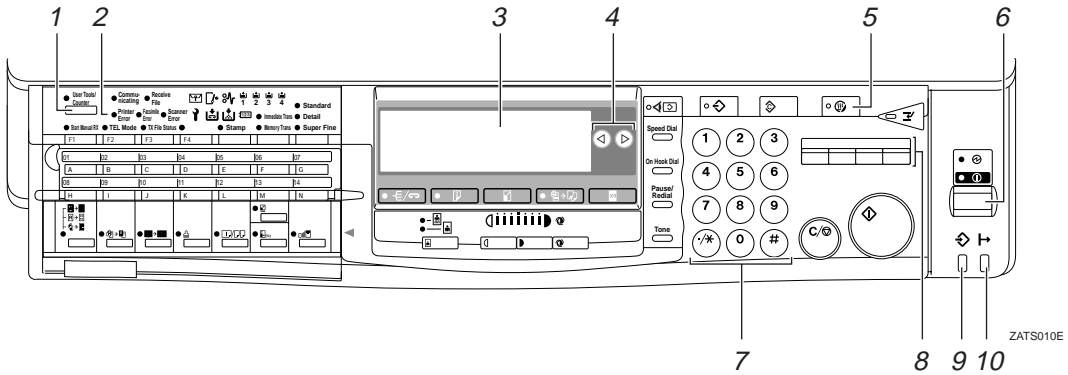

### 1. [User Tools] key

Press to change the default settings and conditions to meet your requirements.

### 2. Error Indicator

Lights up whenever a printer error occurs. A message describing the cause of the error also appears on the panel display.

### 3. Panel Display

Shows the operation status, error messages, and function menus. Press selection keys to select the function on the panel display.

### 4. ⏪ ⏩ keys

### 5. [Energy Saver] key

Press this key for about 1 second to switch to and from Energy Saver mode.

### 6. Operation Switch

Press this switch to turn the power on (the On indicator lights up). To turn the power off, press this switch again (the On indicator goes off).

### 7. Number keys

### 8. Function keys

Press to change the functions (Copy, Facsimile, Printer) shown on the panel display. To use the printer function, press the [Printer] key.

### 9. Data In Indicator

Shows if a print job is being sent from the host computer.

If the indicator is blinking, a job is being sent.

If the indicator stays on the data is printing.

### 10. On Line Indicator

Stays on while the printer is online.

## Panel Display

The panel display shows operational status, error messages, and function menus.

### Important

- Do not apply a strong shock or a force of about 30N (about 3kgf) or more to the panel display. Otherwise, the display might be damaged.

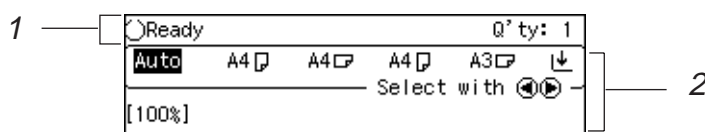

**1. Operation and Error Messages appear.**

**2. Items can be selected or specified. These keys correspond to the keys**

**that are in the bottom line of the display.**

### Note

- The selected item is highlighted on the panel display.

## Basic Key Operations

The following table shows basic key operations.

<b>[Enter #]</b> key	Press this key to set the function or numeric value, and the previous display appears.
<b>[Escape]</b> key	Press this key to cancel the function or numeric value, and the previous display appears.
<b>[↑][↓]</b> keys	If all functions cannot be displayed, press these keys to switch to the previous or next page. Increase or decrease the counter on the display panel.
<b>[Cancel]</b> key	Press this key to cancel the function, and previous display appears.
<b>[Exit]</b> key	Press this key to set the function or numeric value, and normal display screen appears.

---

## Online and Offline

---

1

---

### Online

---

Online is the state in which the printer can receive data from the computer.



#### 1. [Job Reset] key

Press this key when the printer is online to cancel the current print job.

#### 2. [Online] key

Press this key to change the online status, the printer offline conditions.

---

### Offline

---

Offline is a state in which the printer cannot receive data from the computer.

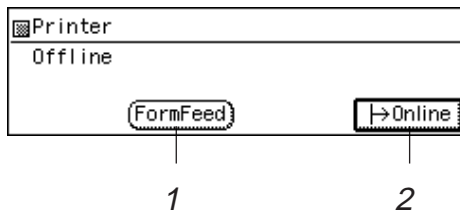

#### 1. [FormFeed] key

Press this key when the printer is offline to print out all the data left in the printer's input buffer.

#### 2. [Online] key

Press this key to change the online status, the printer offline conditions.



# 2. Configuring the Printer for the Network with the Operation Panel

## Configuring the Printer for the Network with the Operation Panel

After installing the optional network interface board, configure it for the network using the printer's operation panel.

The following table shows the operation panel settings and their default settings. These are included in the "Main Menu".

	Items	Default
32	IP Address	011.022.033.044
33	Subnet Mask	000.000.000.000
34	Gateway Address	000.000.000.000
35	Access Control (Access Control Address)	000.000.000.000
36	Access Mask (Access Control Mask)	000.000.000.000
37	Network Boot	None
38	Frame Type(NW) (Frame Type NetWare)	Auto Select
39	ActiveProtocols	All Active

**1** Press [User Tools].

**2** Press [4] on the number keys.

**3** Press [↓] or [↑] until the following message appears.

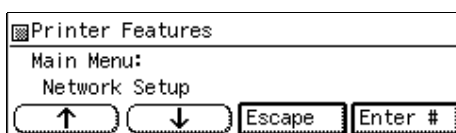

**4** Press [Enter #].

**5** Select the protocol you want to use. You can select one of the items on the following table.

Menu item on the panel display	Active Protocol			
	TCP *1	NW *2	AT *3	NB *4
All Active (Default Setting)	✓	✓	✓	✓
None				
TCP/IP Only	✓			
NetWare Only		✓		
TCP/IP & NetW	✓	✓		
ATalk Only			✓	
TCP/IP & ATalk	✓		✓	
NetWare & ATalk		✓	✓	
TCP & ATK & NW	✓	✓	✓	
NetBEUI only				✓
TCP/IP & NB	✓			✓
NetBEUI & NetW		✓		✓
TCP & NB & NW	✓	✓		✓
NetBEUI & ATalk			✓	✓
TCP & NB & ATK	✓		✓	✓
NB & NW & ATalk		✓	✓	✓

- ✓ means that this protocol is active.
- Blank cell means that this protocol is not active.

\*1 TCP/IP  
 \*2 NetWare  
 \*3 AppleTalk  
 \*4 NetBEUI

**Note**

- You should not select protocols that are not used on your network.

**Limitation**

- If you want to select AppleTalk, you should install the optional PostScript kit Type 185.

**1** Press [↓] or [↑] until the following message appears.

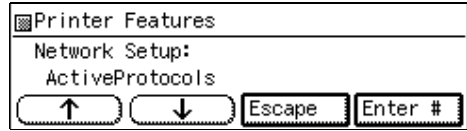

**2** Press [Enter #].

The current settings appear on the panel display.

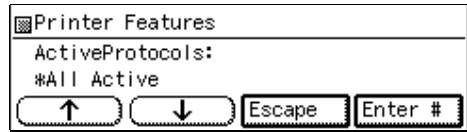

**3** Press [↓] or [↑] until the protocol you want to use appears.

**4** Press [Enter #].

The actual procedure may differ depending on the protocol you use. Follow the appropriate procedure below.

TCP/IP	6 ▶ 7 ▶ 8 ▶ 9 ▶ 11
NetWare	10 ▶ 11
AppleTalk	11
NetBEUI	11

**6** If you use TCP/IP, you should assign the IP Address to your printer.

**Note**

- To get the IP Address for your printer, contact your network administrator.
- The IP Address is shown by Byte on the panel display.

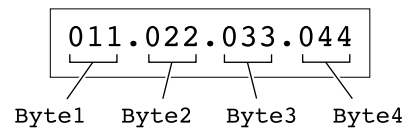

- 1 Press [↓] or [↑] until the following message appears.

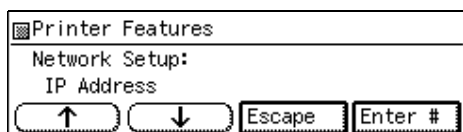

- 2 Press [Enter #].

The current Byte 1 of the IP Address appears on the panel display.

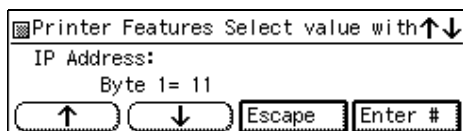

- 3 Use [↑] or [↓] to specify the IP Address.

- 4 Press [Enter #].

The current Byte 2 of the IP Address appears.

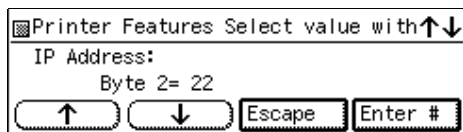

- 5 Use [↑] or [↓] to specify the Byte 2 of the IP Address.

Repeat steps 3 and 4 to specify the rest of the IP Address.

- 6 Press [Enter #] to register the IP Address you specified.

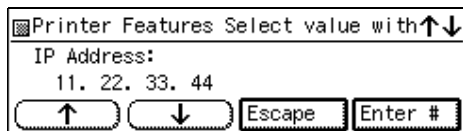

- 7 If you use TCP/IP, you should assign the "Subnet Mask" and "Gateway Address" following the same procedure for specifying the IP Address.

- 8 If you use TCP/IP, set the "Access Control" and "Access Mask" following the same procedure for specifying the IP Address, if necessary.

- 9 If you use TCP/IP, you can make settings for "Network Boot".

You can select how to assign the printer's address using the computer. Select one of the items on the following table.

Menu item on the panel display	Available method			
	AR *1	RA *2	BO *3	DH *4
ARP + PING	✓			
ARP & RARP	✓	✓		
ARP & BOOTP	✓		✓	
ARP&RARP&BOOTP	✓	✓	✓	
None (Default Setting)				
RARP + TFTP		✓		
BOOTP			✓	
RARP & BOOTP		✓	✓	
DHCP				✓

- \*1 ARP + PING
- \*2 RARP + TFTP
- \*3 BOOTP
- \*4 DHCP

**Note**

- You should set up your server, if you want to use "RARP + TFTP", "BOOTP", or "DHCP".

- 1 Press [↓] or [↑] until the following message appears.

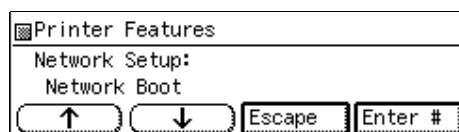

- 2 Press [Enter #].

The current setting appears on the panel display.

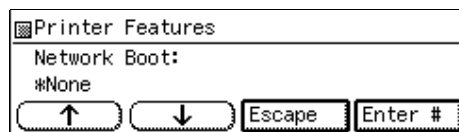

- 3 Press [↓] or [↑] until the method you want to use appears.

- 4 Press [Enter #].

**10** If you use NetWare, select the frame type for NetWare.

Select one of the items below if necessary.

- Auto Select (Default)
- Ethernet 802.3
- Ethernet 802.2
- Ethernet II
- Ethernet SNAP

**Note**

Usually, you can use the default setting ("Auto Select"). With "Auto Select", the frame type detected by the printer first is adopted. If your network can use more than two frame types, the printer may fail to select the correct frame type. In this case, select the appropriate frame type.

**1** Press [↓] or [↑] until the following message appears.

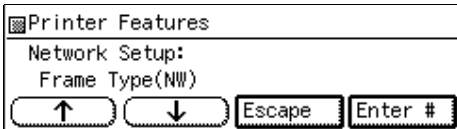

**2** Press [Enter #].

The current setting appears on the panel display.

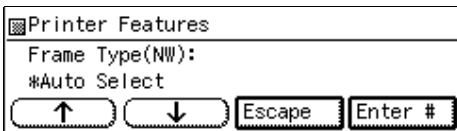

**3** Press [↓] or [↑] until the frame type you want to use appears.

**4** Press [Enter #].

**11** Exit from the setup menu to the available function settings.

- 1** Press [Escape].
- 2** Press [Escape].
- 3** Press [Exit].

**12** When printing a configuration page, confirm of your printer's configuration.

**1** Press [User Tools].

**2** Press [4] on the number keys.

**3** Press [↓] or [↑] to display "List Print", and then press [Enter #].

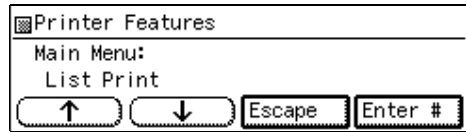

**4** After confirming that "Config. Page" is displayed, press [Enter #].

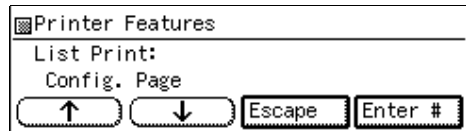

**5** Press [Enter #].

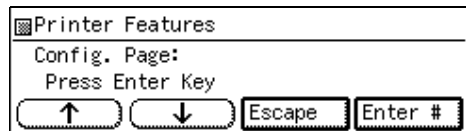

Confirm of your printer's configuration by printing a configuration page.

 **Address**
**❖ Subnet Mask**

A number used to mathematically "mask" or hide IP Address on the network by eliminating those parts of the address that are alike for all the machines on the network.

**❖ Gateway Address**

A gateway is a connection or interchange point that connects two networks. A gateway address is for the router or host computer used as a gateway.

 **Note**

- To get the addresses, contact your network administrator.

**❖ Access Control Address and Access Control Mask**

Access Control Address and Access Control Mask are used to control the IP Address that have access to the computer used for printing, with the IP Address. If it is not necessary for you to control the access rights, select "0.0.0.0".

 **Note**

- When the Access Control Address settings coincide with the masked result of the IP Address of the computer, print jobs from that IP Address can be accepted by the network interface board.
- For example, if you assign 192.168.15.16 as the Access Control Address to the network interface board, the combination of the Access Control Mask and IP Address that can have access are as follows. (xxx: for any numerical value)

Access Control Mask	IP Address that have access
0 . 0 . 0 . 0	xxx . xxx . xxx . xxx
255 . 0 . 0 . 0	192 . xxx . xxx . xxx
255 . 255 . 0 . 0	192 . 168 . xxx . xxx
255 . 255 . 255 . 0	192 . 168 . 15 . xxx
255 . 255 . 255 . 255	192 . 168 . 15 . 16

2

# 3. Installing the Printer Driver and Software

All of the procedures in this manual assume that you are familiar with general Windows procedures and practices. If you are not, see the documentation that comes with Windows for details.

## Auto Run

You can install the printer driver by using Auto Run.

Auto Run is available for the following operating systems:

- Windows 95/98
- Windows NT 4.0

If your system is Windows 3.1x or Macintosh, see information on installing the printer driver.

⇒ P.20 “Windows 95/98 - Installing the PCL 6/5e Printer Driver”.

⇒ P.21 “Windows 3.1x - Installing the PCL 6/5e Printer Driver”.

⇒ P.27 “Macintosh”.

### Important

- Before starting this installation, close all documents and applications. In a network environment, confirm that users who are logged on are disconnected. Be sure to do this when it will create the least interference with other users.
- After installing a printer driver, you must restart the computer.

### Limitation

- If your system is Windows NT 4.0, installing a printer driver requires Full Control access permission. Members of the Administrators, Server Operators, Print Operators, and Power Users groups have Full Control permission by default. When you install a printer driver, log on under Full Control permission.
- If your system uses Windows NT 4.0 and Service Pack 4 is installed, you might not install the PCL 6/5e printer driver using Auto Run. In this case, use **[Add Printer Wizard]** in the **[Printers]** window to install the printer driver or install Service Pack 5 in the computer before installing the printer driver.

### Reference

For more information on the software and utilities included on the CD-ROM, see P.19 “Software and Utilities Included on the CD-ROM”.

### Note

- Auto Run might not automatically work with certain OS settings. In this case, start "SETUP.EXE" to install printer driver on the root.
- If you want to cancel Auto Run, insert the CD-ROM while pressing the **[SHIFT]** key until your computer finishes accessing the CD-ROM.

.....

## Using the Shared Printer on Windows NT 4.0 for Windows 95/98 Client

If you want to share the printer on Windows NT 4.0, you must not install the printer driver using Auto Run. Install the printer driver of the Windows 95/98 for alternate driver.

For more information on installing the printer driver as an alternate driver, see P.20 "Windows NT 4.0 - Installing the PCL 6/5e Printer Driver".

.....

## 3

---

### Installing by Auto Run

---

Follow these steps to install the printer driver on Windows 95/98/NT 4.0.

#### Important

- Never have two versions of the same printer driver installed on your system at the same time. When upgrading to a new version of the printer driver, uninstall the old version, and then install the new one. For more information on uninstalling the printer driver and software, see P.29 "Uninstalling the Printer Driver and Software".

#### Note

- If the "plug and play" function is started by Auto Run, click **[Cancel]** of the **[New Hardware Found]** dialog box or **[Device Driver Wizard]**, and then insert the CD-ROM. **[New Hardware Found]** or **[Device Driver Wizard]** appears depending on the system version of the Windows 95/98.
- The appropriate language name is used in the CD-ROM folder: ENGLISH (English), DEUTSCH (German), FRANCAIS (French), ITALIANO (Italian), ESPANOL (Spanish), NEDRLNDS (Dutch), NORSK (Norwegian), DANSK (Danish), SVENSKA (Swedish), POLSKI (Polish), PORTUGUS (Portuguese), SUOMI (Finnish), MAGYAR (Hungarian), CESKY (Czechoslovakian)

- 1** Close all applications that are currently running.
- 2** Insert the CD-ROM in the CD-ROM drive.
- 3** Follow the instructions on the screen.
- 4** Restart your computer after installation is complete.
- 5** You should set up the options with the printer driver.



# Software and Utilities Included on the CD-ROM

## ❖ Agfa Font Manager

Helps you to install new fonts, or organize and manage fonts already installed on your system.

## ❖ PRINTER MANAGER FOR ADMINISTRATOR

A utility for the system administrator to manage printers on the network.

### Reference

For the name of the PRINTER MANAGER FOR ADMINISTRATOR you use, see the "Operating Instruction" for the optional Network Interface Board which is on the CD-ROM.

See the PRINTER MANAGER FOR ADMINISTRATOR Online Help for details on using the PRINTER MANAGER FOR ADMINISTRATOR.

## ❖ PRINTER MANAGER FOR CLIENT

A utility for users to manage their own print jobs on the network.

### Reference

For the name of the PRINTER MANAGER FOR CLIENT you use, see the "Operating Instruction" for the optional Network Interface Board which is included in the CD-ROM.

See the PRINTER MANAGER FOR CLIENT Online Help for details on using the PRINTER MANAGER FOR CLIENT.

## ❖ Multidirect Print

A utility for printing on a "Peer-to-Peer" network.

### Reference

For more information on Multidirect Print, see the "Operating Instructions" for the optional Network Interface Board which is included in the CD-ROM.

## ❖ PortNavi

A utility that helps you to use network printers effectively. It is useful in environments where two or more network printers are used.

### Reference

For more information on PortNavi, see the "Supplement" for the Network Interface Board which is included in the CD-ROM.

## ❖ Acrobat Reader

A utility that allows you to read PDF (Portable Document Format).

### Note

- Documentation on using the printer is included on the CD-ROM in PDF format.

# Installing the PCL 6/5e Printer Driver

---

## Windows 95/98 - Installing the PCL 6/5e Printer Driver

---

### Installing the Printer Driver

---

Install the driver in accordance with the steps explained. ⇒ P.18 “*Installing by Auto Run*”

---

### Setting Up Options

---

 **Note**

When setting up options, you should access the Printer Properties from Windows. You cannot access the Printer Properties from an application.

**1** Click **[Start]** on the task bar, point to **[Settings]**, and then click **[Printers]**.

The **[Printers]** window appears.

**2** Click the icon of the printer you want to use. On the **[File]** menu, click **[Properties]**.

**3** Click the **[Accessories]** tab.

**4** Select any options you have installed from the **[Options]** group.

**5** Click **[OK]**.

---

## Windows NT 4.0 - Installing the PCL 6/5e Printer Driver

---

### Installing the Printer Driver

---

 **Important**

If your system uses Windows NT 4.0 and Service Pack 4 is installed, you might not install the PCL 6/5e printer driver using Auto Run. In this case, use **[Add Printer Wizard]** in the **[Printers]** window to install the printer driver or install Service Pack 5 in the computer before install the printer driver.

Install the driver in accordance with the steps explained. ⇒ P.18 “*Installing by Auto Run*”

If you want to share the printer on Windows NT 4.0, you must not install the printer driver using Auto Run. In this case, cancel Auto Run and install the printer driver using **[Add Printer Wizard]** in the **[Printers]** window.

When prompted for Windows NT 4.0 alternate driver location, specify the following folder in the CD-ROM.

- PCL 5e  
  \DRIVERS\PCL5E\NT4\(\Lauguage)\DISK1\
- PCL 6  
  \DRIVERS\PCL6\NT4\(\Lauguage)\DISK1\

When prompted for Windows 95/98 alternate driver location, specify the following folder in the CD-ROM.

- PCL 5e  
  \DRIVERS\PCL5E\WIN95\_98\(\Lauguage)\DISK1\
- PCL 6  
  \DRIVERS\PCL6\WIN95\_98\(\Lauguage)\DISK1\

3

---

## Setting Up Options

---

### Limitation

- Changing the setting of the printer requires Full Control access permission. Members of the Administrators, Server Operators, Print Operators, and Power Users groups have Full Control permission by default. When you set up options, log on under Full Control permission.

### Note

- When setting up options, you should access the Printer Properties from Windows. You cannot access the Printer Properties from an application.

**1** Click **[Start]** on the task bar, point to **[Settings]**, and then click **[Printers]**.  
The **[Printers]** window appears.

**2** Click the icon of the printer you want to use. On the **[File]** menu, click **[Properties]**.

**3** Click the **[Accessories]** tab.

**4** Select any options you have installed from the **[Options]** group.

**5** Click **[OK]**.

---

## Windows 3.1x - Installing the PCL 6/5e Printer Driver

---

### Installing the Printer Driver

---

### Important

- We recommend you to install the PCL 5e printer driver on your Windows 3.1x system. Under Windows 3.1x system, you might get some unexpected print results with the PCL 6 printer driver.

**1** Close all the applications that are currently running.

- 2** Insert the CD-ROM in the CD-ROM drive.
- 3** From [Program Manager], click [Run] on the [File] menu.
- 4** In the [Run] window, click [Browse].
- 5** Select the CD-ROM drive in the [Drives:] list.
- 6** Open [PCL5E] or [PCL6].
- 7** Open [WIN31].
- 8** Open the folder of the language you use.
- 9** Open [DISK1].
- 10** Double-click "SETUP.EXE".
- 11** Follow the instructions on the screen.

---

### Setting Up Options

---

 **Note**

- When setting up options, you should access the Printer Setting dialog box from Windows. You cannot access the Printer Setting dialog box from an application.

- 1** From the [Main] group of [Program Manager], double-click [Control Panel].
- 2** Double-click the [Printers] icon.
- 3** In the [Installed Printers:] list, click the name of the printer you want to set up.
- 4** Click [Setup].
- 5** Click the [Accessories] tab.  
The [Options] group appears.
- 6** Select any options you have installed from the [Options] group.
- 7** Click [OK] to close the Printer Setting dialog box.
- 8** Click [Close] to close the [Printers] dialog box.

---

# Installing the PostScript Printer Driver

---

---

## Windows 95/98 - Installing the PostScript Printer Driver

---

---

### Installing the Printer Driver

---

Install the driver in accordance with the steps explained. ⇒ P.18 *“Installing by Auto Run”*

---

---

### Setting Up Options

---

 **Note**

- When setting up options, you should access the **[Device Options]** tab from Windows. You cannot set up options when accessing the **[Device Options]** tab from an application.

**1** Click **[Start]** on the task bar, point to **[Settings]**, and then click **[Printers]**.

The **[Printers]** window appears.

**2** Click the icon of the printer you want to use. On the **[File]** menu, click **[Properties]**.

**3** Click the **[Device Options]** tab.

The **[Installable options]** group appears.

**4** From the **[Installable options]** box, select the option you have installed.

The current setting is displayed in the **[Change settings for:]** list.

**5** Use the **[Change setting for:]** list to select the appropriate setting for the selected option.

**6** Click **[Apply]** to apply the settings you made.

**7** After making all settings you want, click **[OK]**.

---

## Windows NT 4.0 - Installing the PostScript Printer Driver

---

---

### Installing the Printer Driver

---

Install the driver in accordance with the steps explained. ⇒ P.18 *“Installing by Auto Run”*

---

## Setting Up Options

---

### Limitation

- Changing the setting of the printer requires Full Control access permission. Members of the Administrators, Server Operators, Print Operators, and Power Users groups have Full Control permission by default. When you set up options, log on under Full Control permission.

### Note

- When setting up options, you should access the Printer Properties from Windows. You cannot set up options when accessing the Printer Properties from an application.

**1** Click **[Start]** on the task bar, point to **[Settings]**, and then click **[Printers]**.

The **[Printers]** window appears.

**2** Click the icon of the printer you want to use. On the **[File]** menu, click **[Properties]**.

**3** Click the **[Device Settings]** tab.

**4** Use the **[Installable Options]** group to specify the options.

**5** Click **[OK]** to close the Printer Properties.

---

## Windows 3.1x - Installing the PostScript Printer Driver

---

---

### Installing the Printer Driver

---

**1** Close all the applications that are currently running.

**2** Insert the CD-ROM in the CD-ROM drive.

**3** From the **[Program Manager]**, click **[Run]** from the **[File]** menu.

**4** In the **[Run]** window, click **[Browse]**.

**5** Select the CD-ROM drive in the **[Drives:]** list.

**6** Open **[PS]**.

**7** Open **[WIN31]**.

**8** Open the folder of the language you use.

**9** Open **[DISK1]**.

**10** Double-click "SETUP.EXE".

- 1** Follow the instructions on the screen.

---

### Setting Up Options

---

- 1** From the [Main] group of [Program Manager], double-click [Control Panel].
- 2** Double-click the [Printers] icon.
- 3** In the [Installed Printers:] list, click the name of the printer you want to set up.
- 4** Click [Setup].
- 5** Click the [Features] tab.  
The [Printer Features] group appears.
- 6** Use the [Printer Features] group to specify the options.
- 7** Click [OK] to close the Printer Setting dialog box.
- 8** Click [Close] to close the [Printers] dialog box.

## Using Adobe PageMaker Version 6.0 or 6.5

If you use the printer under Windows 95/98/NT 4.0 with Adobe PageMaker, you need to copy the PPD file to the PageMaker folder.

The PPD file is the file with extension ".ppd". It is in the folder "\PS\WIN95\_98\ (Language)\DISK1\" on the CD-ROM.

The **[WIN95\_98]** folder, inside the **[PS]** folder is for the Windows 95/98 operating system. Use the folder at this level that is appropriate for the operating system you are using.

The third folder, "(Language)" may be substituted by appropriate language name.

Copy this file to the PageMaker folder.

For the PageMaker 6.0 default installation, the folder is "C:\PM6\RSRC\PPD4", and for the PageMaker 6.5 default installation, the directory is "C:\PM65\RSRC\USENGLISH\PPD4". The "USENGLISH" may be different, depending on your language selection.

### Reference

For more information on the language name, see P.18 *Installing by Auto Run*.



# Macintosh

---

## Macintosh - Installing the PostScript Printer Driver

---

It is necessary to install a printer driver and a PPD file to print from a Macintosh. Follow these steps to install a printer driver and a PPD file into a Macintosh using a system 7.1 or later operating system.

### Important

- You cannot use LaserWriter 8.5.0 or later with Mac OS 8.1 or later until you do the following procedure. Copy the “PrintingLib” file from the **[Extensions]** folder in **[System Folder]** to your desktop before installing the PostScript printer driver. After installing the PostScript printer driver, drag the “PrintingLib” file from your desktop back into the **[Extensions]** folder.
- If you forgot to copy the “PrintingLib” file, please reinstall the Macintosh operating system again.

- 1** Insert the CD-ROM in the CD-ROM drive.
- 2** Double-click the CD-ROM icon.
- 3** Double-click the **[PS]** folder.
- 4** Double-click the folder of the language you use.
- 5** Open **[DISK1]** and double-click the installer icon.
- 6** Follow the instructions on the screen.
- 7** Move the “PrintingLib” file from your desktop back to **[Extensions]** in **[System Folder]**.
- 8** Double-click **[Extensions]**.
- 9** Double-click **[Printer Descriptions]**.
- 10** Double-click the CD-ROM icon on the desktop.
- 11** Double-click **[DISK1]** in the folder of the language you use.
- 12** Click and drag the PPD file into **[Printer Descriptions]**.
- 13** Click and drag the “Proof Print” file into **[Printer Descriptions]** in **[Extensions]** in **[System Folder]**.
- 14** Restart the Macintosh.

---

## Setting Up the PPD File

---

### Preparation

Confirm that the printer is connected to an AppleTalk network before performing the following procedure.

- 1** On the **[Apple]** menu, select **[Chooser]**.
- 2** Click the **[Adobe PS]** icon.
- 3** In the **[Select a PostScript Printer:]** list, click the name of the printer you want to use.
- 4** Click **[Create]**.
- 5** Click the printer you want to use, and then click **[Select]**.

The PPD file is set up, and the **[Adobe PS]** icon appears at the left of the printer name in the list. Next, use the procedure on P.28 “*Setting Up Options*” to make the option settings, or close the **[Chooser]** dialog box.

---

## Setting Up Options

---

- 1** On the **[Apple]** menu, select **[Chooser]**.
- 2** Click the **[Adobe PS]** icon.
- 3** In the **[Select the PostScript Printer:]** list, click the name of the printer you want to use, and then click **[Setup]**.
- 4** Click **[Configure]**.  
A list of options appears.
- 5** Select the option you want to set up and select the appropriate setting for it.

### Note

- If the option you want to set up is not displayed, the PPD file might not be set up correctly. Check the name of the PPD file shown in the dialog box.

- 6** Click **[OK]**.  
The list of options closes.
- 7** Click **[OK]**.  
The **[Chooser]** dialog box appears.
- 8** Close the **[Chooser]** dialog box.

# 4. Uninstalling the Printer Driver and Software

## Uninstalling the PCL 6/5e Printer Driver

This section describes how to uninstall the printer driver. The actual procedure may differ depending on your operating system.

Follow the appropriate procedure.

---

### Windows 95/98 - Uninstalling the PCL 6/5e Printer Driver

---

- 1** Close all the applications that are currently running.
- 2** Click **[Start]** on the task bar, point to **[Settings]**, and then click **[Printers]**.  
The **[Printers]** window appears.
- 3** Click the icon of the printer you want to remove.
- 4** On the **[File]** menu, click **[Delete]**.  
A confirmation dialog box appears.
- 5** Click **[Yes]** to uninstall the printer driver.

---

### Windows NT 4.0 - Uninstalling the PCL 6/5e Printer Driver

---

#### Limitation

- Uninstalling the printer driver requires Full Control access Permission. Members of the Administrators, Server Operators, Print Operators, and Power Users groups have Full Control permission by default. When you uninstall a printer driver, log on under Full Control permission.

- 1** Close all the applications that are currently running.
- 2** Click **[Start]** on the task bar, point to **[Settings]**, and click **[Printers]**.  
The **[Printers]** window appears.
- 3** Click the icon of the printer you want to remove.
- 4** On the **[File]** menu, click **[Delete]**.  
A confirmation dialog box appears.
- 5** Click **[Yes]** to uninstall the printer driver.

---

## Windows 3.1x - Uninstalling the PCL 6/5e Printer Driver

---

- 1** Close all applications that are currently running.
- 2** Insert the CD-ROM in the CD-ROM drive.
- 3** From [Program Manager], select [Run] from the [File] menu.
- 4** In the [Run] window, click [Browse].
- 5** Select the CD-ROM drive in the [Drives:] list.
- 6** Open [PCL5E] or [PCL6].
- 7** Open [WIN31].
- 8** Open the folder of the language you use.
- 9** Open [DISK1].
- 10** Double-click "UNSETUP.EXE".
- 11** Click [OK].
- 12** Click [OK].
- 13** Follow the instructions on the screen.
- 14** If you are asked if you want to restart Windows, select [Restart Windows Now].  
If you are not asked, restart Windows after completing the uninstallation.

# Uninstalling the PostScript Printer Driver

This section describes instructions for uninstalling the PostScript printer driver. The actual procedure may differ depending on your operating system.

Follow the appropriate one of the following procedures below.

---

## Windows 95/98 - Uninstalling the PostScript Printer Driver

---

- 1** Close all applications that are currently running.
- 2** Click **[Start]** on the task bar, point to **[Settings]**, and then click **[Printers]**.  
The **[Printers]** window appears.
- 3** Click the icon of the printer you want to remove.
- 4** On the **[File]** menu, click **[Delete]**.  
A confirmation dialog box appears.
- 5** Click **[Yes]** to uninstall the printer driver.

---

## Windows NT 4.0 - Uninstalling the PostScript Printer Driver

---

### Limitation

- Uninstalling the printer driver requires Full Control access Permission. Members of the Administrators, Server Operators, Print Operators, and Power Users groups have Full Control permission by default. When you uninstall a printer driver, log on under Full Control permission.

- 1** Close all applications that are currently running.
- 2** Click **[Start]** on the task bar, point to **[Settings]**, and then click **[Printers]**.  
The **[Printers]** window appears.
- 3** Click the icon of the printer you want to remove.
- 4** On the **[File]** menu, click **[Delete]**.  
A confirmation dialog box appears.
- 5** Click **[Yes]** to uninstall the printer driver.

---

## Windows 3.1x - Uninstalling the PostScript Printer Driver

---

- 1** Open [Control Panel].
- 2** Double-click the [Printers] icon.
- 3** Select the printer you want to delete and click [Remove].  
A confirmation dialog box appears.
- 4** Click [Yes] to uninstall the printer driver.
- 5** Click [Close] to close the [Printers] dialog box.

## 4

---

## Macintosh - Uninstalling the PostScript Printer Driver

---

- 1** Drag the "AdobePS" file inside the [Extensions] folder in [System Folder] to [Trash].
- 2** Drag the "Proof Print" file inside the [Printer Descriptions] folder in the [Extensions] folder in [System Folder] to [Trash].

# 5. Setting Up the Printer Driver and Canceling a Print Job

## PCL 6/5e - Accessing the Printer Properties

---

### Windows 95/98 - Accessing the Printer Properties

---

There are two methods you can use to open the Printer Properties.

---

#### Making Printer Default Settings

---

To make the printer default settings, first open the Printer Properties from the **[Printers]** window.

**1** Click **[Start]** on the task bar, point to **[Settings]**, and then click **[Printers]**.

The **[Printers]** window appears.

**2** Click the icon of the printer whose default settings you want to change.

**3** On the **[File]** menu, click **[Properties]**.

The Printer Properties appears.

**4** Set desired settings and click **[OK]**.

---

#### Making Printer Settings From an Application

---

To make the printer settings for a specific application, open the Printer Properties from that application. The following example describes how to make settings for the WordPad application that comes with Windows 95/98.

#### Note

- The actual procedures you should follow to open the Printer Properties may differ depending on the application. For details, see the documentation that comes with the application you are using.
- When you use some applications, the driver's initial default settings of the applications might be applied over the printer driver's setting.
- Any settings you make in the following procedure are valid for the current application only.

**1** On the **[File]** menu, click **[Print]**.

The **[Print]** dialog box appears.

**2** From the **[Name:]** list, select the printer you want to use, and then click **[Properties]**.

The Printer Properties appears.

**3** Set desired settings and click **[OK]**.

**4** Click **[OK]** to start your printing.

---

## Windows NT 4.0 - Accessing the Printer Properties

---

---

### Making Printer Default Settings - Printer Properties

---

 **Limitation**

- Changing the settings of the printer requires Full Control access permission. Members of the Administrators, Server Operators, Print Operators, and Power Users groups have Full Control permission by default. When you set up options, log on under Full Control permission.

**1** Click **[Start]** on the task bar, point to **[Settings]**, and then click **[Printers]**.

The **[Printers]** window appears.

**2** Click the icon of the printer whose default setting you want to change.

**3** On the **[File]** menu, click **[Properties]**.

The Printer Properties appears.

**4** Set desired settings and click **[OK]**.

 **Note**

- Settings you make here are used as the default settings for all applications.

---

### Making Printer Default Settings – Default Document Properties

---

 **Limitation**

- Changing the settings of the printer requires Full Control access permission. Members of the Administrators, Server Operators, Print Operators, and Power Users groups have Full Control permission by default. When you set up options, log on under Full Control permission.

**1** Click **[Start]** on the task bar, point to **[Settings]**, and then click **[Printers]**.

The **[Printers]** window appears.

**2** Click the icon of the printer whose default settings you want to change.

**3** On the **[File]** menu, click **[Document Defaults]**.

The Default Document Properties appears.

**4** Set desired settings and click **[OK]**.

 **Note**

- Settings you make here are used as the default settings for all applications.



---

## Making Printer Settings From an Application

---

To make the printer settings for a specific application, open the Document Properties from that application. The following example describes how to make settings for the WordPad application that comes with Windows NT 4.0.

### Note

- The actual procedures you should follow to open the Document Properties may differ depending on the application. For details, see the documentation that comes with the application you are using.
- Any settings you make in the following procedure are valid for the current application only.

### **1** On the [File] menu, click [Print].

The [Print] dialog box appears.

### **2** From the [Name:] list, select the printer you want to use, and then click [Properties].

The Document Properties appears.

### **3** Set desired settings and click [OK].

### **4** Click [OK] to start your printing.

---

## Windows 3.1x - Accessing the Printer Setting Dialog Box

---

There are two methods you can use to open the Printer Setting dialog box.

---

### Making Printer Default Settings

---

To make the printer default settings, open the Printer Setting dialog box from [Control Panel].

### **1** From [Program Manager], open the [Main] group.

### **2** Double-click [Control Panel].

### **3** Double-click the [Printers] icon.

### **4** In the [Installed Printers:] list, click the name of the printer you want to set up.

### **5** Click [Setup].

### **6** Set desired settings and click [OK].

### **7** Click [Close] to close the [Printers] dialog box.

---

## Making Printer Settings from an Application

---

To make the printer settings for a specific application, open the Printer Setting dialog box from that application. The following example describes how to make settings for the Write application that comes with Windows 3.1x.

 **Note**

- The actual procedures you should follow to open the Printer Setting dialog box may differ depending on the application. For details, see the documentation that comes with the application you are using.
- When you use some applications, the driver's initial default settings of the applications might be applied over the printer driver's setting.
- Any settings you make in the following procedure are valid for the current application only.

**1** On the **[File]** menu, click **[Print Setup]**.

The **[Print Setup]** dialog box appears.

**2** From the **[Printer]** group, select the printer you want to use.

 **Note**

- If the printer you want to use is not specified as the default printer, click **[Specific Printer:]**, and then find the printer you want to use in the list box.

**3** Click **[Options]**.

The Printer Setting dialog box appears.

**4** Set desired settings and click **[OK]**.

**5** Click **[OK]** to close the **[Print Setup]** dialog box.

**6** Start your printing.

---

# PostScript - Setting Up for Printing

---

---

## Windows 95/98 - Accessing the Printer Properties

---

There are two methods you can use to open the Printer Properties.

---

### Making Printer Default Settings

---

To make the printer default settings, first open the Printer Properties from the **[Printers]** window.

- 1** Click **[Start]** on the task bar, point to **[Settings]**, and then click **[Printers]**.

The **[Printers]** window appears.

- 2** Click the icon of the printer whose default settings you want to change.

- 3** On the **[File]** menu, click **[Properties]**.

The Printer Properties appears.

- 4** Set desired settings and click **[OK]**.

---

### Making Printer Settings from an Application

---

To make the printer settings for a specific application, open the Printer Properties from that application. The following example describes how to make settings for the WordPad application that comes with Windows 95.

 **Note**

- The actual procedures you should follow to open the Printer Properties may differ depending on the application. For details, see the documentation that comes with the application you are using.
- When you use some applications, the driver's initial default settings of the applications might be applied over the printer driver's setting.
- Any settings you make in the following procedure are valid for the current application only.

- 1** On the **[File]** menu, click **[Print]**.

The **[Print]** dialog box appears.

- 2** From the **[Name:]** box, select the printer you want to use, and then click **[Properties]**.

The Printer Properties appears.

- 3** Set desired settings and click **[OK]**.

- 4** Click **[OK]** to start your printing.

---

## Windows NT 4.0 - Accessing the Printer Properties

---

---

### Making Printer Default Settings - Printer Properties

---

 **Limitation**

- Changing the settings of the printer requires Full Control access permission. Members of the Administrators, Server Operators, Print Operators, and Power Users groups have Full Control permission by default. When you set up options, log on under Full Control permission.

**1** Click **[Start]** on the task bar, point to **[Settings]**, and then click **[Printers]**.

The **[Printers]** window appears.

**2** Click the icon of the printer whose default settings you want to change.

**3** On the **[File]** menu, click **[Properties]**.

The Printer Properties appears.

**4** Set desired settings and click **[OK]**.

 **Note**

- Settings you make here are used as the default settings for all applications.

---

### Making Printer Default Settings - Default Document Properties

---

 **Limitation**

- Changing the settings of the printer requires Full Control access permission. Members of the Administrators, Server Operators, Print Operators, and Power Users groups have Full Control permission by default. When you set up options, log on under Full Control permission.

**1** Click **[Start]** on the task bar, point to **[Settings]**, and then click **[Printers]**.

The **[Printers]** window appears.

**2** Click the icon of the printer whose default settings you want to change.

**3** On the **[File]** menu, click **[Document Defaults]**.

The Default Document Properties appears.

**4** Set desired settings and click **[OK]**.

 **Note**

- Settings you make here are used as the default settings for all applications.

---

## Making Printer Settings from an Application

---

To make the printer settings for a specific application, open the Document Properties from that application. The following example describes how to make settings for the WordPad application that comes with Windows NT 4.0.

### Note

- The actual procedures you should follow to open the Document Properties may differ depending on the application. For details, see the documentation that comes with the application you are using.
- Any settings you make in the following procedure are valid for the current application only.

### **1** On the [File] menu, click [Print].

The [Print] dialog box appears.

### **2** From the [Name:] box, select the printer you want to use, and then click [Properties].

The Document Properties appears.

### **3** Set desired settings and click [OK].

### **4** Click [OK] to start your printing.

---

## Windows 3.1x - Accessing the Printer Setting Dialog Box

---

There are two methods you can use to open the Printer Setting dialog box.

---

### Making Printer Default Settings

---

To make the printer default settings, open the Printer Setting dialog box from [Control Panel].

### **1** From [Program Manager], open the [Main] group.

### **2** Double-click [Control Panel].

### **3** Double-click the [Printers] icon.

### **4** In the [Installed Printers:] box, click the name of the printer you want to set up.

### **5** Click [Setup].

### **6** Set desired settings and click [OK].

### **7** Click [Close] to close the [Printers] dialog box.

---

## Making Printer Settings from an Application

---

To make the printer settings for a specific application, open the Printer Setting dialog box from that application. The following example describes how to make settings for the Write application that comes with Windows 3.1x.

 **Note**

- The actual procedures you should follow to open the Printer Setting dialog box may differ depending on the application. For details, see the documentation that comes with the application you are using.
- When you use some applications, the driver's initial default settings of the applications might be applied over the printer driver's setting.
- Any settings you make in the following procedure are valid for the current application only.

**1** On the [File] menu, click [Print Setup].

The [Print Setup] dialog box appears.

**2** From the [Printer] group, select the printer you want to use.

 **Note**

- If the printer you want to use is not specified as the default printer, click [Specific Printer:], and then find the printer you want to use in the list box.

**3** Click [Options].

The Printer Setting dialog box appears.

**4** Set desired settings and click [OK].

**5** Click [OK] to close the [Print Setup] dialog box.

**6** Start your printing.

---

## Macintosh - Setting Up for Printing

---

---

### Making Paper Settings from an Application

---

**1** Open the file you want to print.

**2** On the [File] menu, click [Page Setup].

[AdobePS Page Setup] appears.

**3** Confirm that the printer you want to use is shown in the [Format for:] box.

 **Note**

- If your printer is now shown in the **[Format for:]** box, use the pop-up menu to display a list of available printers.

 **Reference**

The actual appearance of the Page Setup depends on the application you are using. See the documentation that comes with your Macintosh for details.

**4** From the **[Paper:]** box, select the paper size.

**5** Set desired settings and click **[OK]**.

---

**Setting up for Printing from an Application**

---

**1** Open the file you want to print.

**2** On the **[File]** menu, click **[Print]**.

The Printer Settings appears.

**3** Confirm that your printer is selected in the **[Printer:]** box.

**4** Set desired settings and click **[Print]**.

# Canceling a Print Job

---

## Windows 95/98 - Canceling a Print Job

---

**1** Double-click the printer icon on the task bar.

This opens a window that shows all the print jobs that are currently queued for printing. Check the current status of the job you want to cancel.

**2** Click the name of the job you want to cancel so that it is highlighted.

**3** On the [Document] menu, click [Cancel Printing].

 **Note**

- You can also open the print job queue window by double-clicking the printer icon in the [Printers] window.

**4** Press the printer's [Job Reset] key.

The message appears on the panel display indicating that the print job is being cancelled.

 **Important**

- When your printer is being shared by multiple computers, be careful not to accidentally cancel someone else's print job.

 **Note**

- You cannot stop printing the data that has already been processed internally by the printer. Because of this, printing might continue for a few pages after you press [Job Reset].
- A print job that contains a large volume of data might take considerable time to stop.
- It takes about 5 minutes to reset the print job, after 5 minutes the printer returns to the ready condition.

---

## Windows NT 4.0 - Canceling a Print Job

---

**1** Double-click the printer icon on the task bar.

This opens a window that shows all the print jobs that are currently queued for printing. Check the current status of the job you want to cancel.

**2** Click the name of the job you want to cancel so that it is highlighted.

**3** On the [Document] menu, click [Cancel].

 **Note**

- You can also open the print job queue window by double-clicking the printer icon in the [Printers] window.



**4** Press the printer's **[Job Reset]** key.

The message appears on the panel display indicating that the print job is being cancelled.

**Important**

- When your printer is being shared by multiple computers, be careful not to accidentally cancel someone else's print job.

**Note**

- You cannot stop printing data that has already been processed internally by the printer. Because of this, printing might continue for a few pages after you press **[Job Reset]**.
- A print job that contains a large volume of data might take considerable time to stop.
- It takes about 5 minutes to reset the print job, after 5 minutes the printer returns to the ready condition.

---

**Windows 3.1x - Canceling a Print Job**

---

5

**1** In the **[Main]** group, double-click the **[Print Manager]** icon.

This opens a window that shows all the print jobs that are currently queued for printing.

**2** Click the name of the job you want to cancel so it is highlighted.**3** On the **[Document]** menu, click **[Delete Document]**.**4** Click **[Close]** to close the dialog box.**5** Press the printer's **[Job Reset]** key.

The message appears on the panel display indicating that the print job is being cancelled.

**Important**

- When your printer is being shared by multiple computers, be careful not to accidentally cancel someone else's print job.

**Note**

- You cannot stop printing data that has already been processed internally by the printer. Because of this, printing might continue for a few pages after you press **[Job Reset]**.
- A print job that contains a large volume of data might take considerable time to stop.
- It takes about 5 minutes to reset the print job, after 5 minutes the printer returns to the ready condition.

---

## Macintosh - Canceling a Print Job

---

**1** Double-click the printer icon on the desktop.

This opens a window that shows all the print jobs that are currently queued for printing. Check the current status of the job you want to cancel.

**2** Click the name of the job you want to cancel so that it is highlighted.

**3** Click the pause icon, and then click the trash icon.

**4** Press the printer's [Job Reset] key.

The message appears on the panel display indicating that the print job is being cancelled.

 **Important**

- When your printer is being shared by multiple computers, be careful not to accidentally cancel someone else's print job.

 **Note**

- You cannot stop printing data that has already been processed internally by the printer. Because of this, printing might continue for a few pages after you press [Job Reset].
- A print job that contains a large volume of data might take considerable time to stop.
- It takes about 5 minutes to reset the print job, after 5 minutes the printer returns to the ready condition.

# 6. Troubleshooting

## Error and Status Messages on the Operation Panel

### Error and Status Messages on the Operation Panel

This section describes instructions for error and status message of the printer function. To use the printer function, press **[Printer]**.

Messages	Description	Comments
Add Staples	The stapler is empty.	Replace the staple refill with a new one.
Cannot Output To Selected Tray	The paper can not be printed to the output tray that you selected.	The paper is printed to another tray that selected by printer.
Dup. Unit In Use Please Wait	AD370 (duplex unit) is used by the other application.	Wait until the other application finished to use AD370 (duplex unit).
Error 1	An error with the optional RAM has occurred.	Turn the printer power off and on. If the message appears again, contact your sales or service representative.
Error 2	An error with the parallel interface board has occurred.	Turn the printer power off and on. If the message appears again, contact your sales or service representative.
Error 3	An error with the NV-RAM has occurred.	Turn the printer power off and on. If the message appears again, contact your sales or service representative.
Error 4	An error with the DIMM has occurred.	Turn the printer power off and on. If the message appears again, contact your sales or service representative.
Error 5	An error with the HDD has occurred.	Install the HDD again. If the message appears again, contact your sales or service representative.
Error 6	An error with the Resident font ROM has occurred.	Turn the printer power off and on. If the message appears again, contact your sales or service representative.

Messages	Description	Comments
Error 7	An error with the ASIC has occurred.	Turn the printer power off and on. If the message appears again, contact your sales or service representative.
Error 30711	AD370 (duplex unit) cannot be used.	Another tray is used to print. Contact your sales or service representative.
Error 30721	PS420 (paper feed unit) cannot be used.	Another tray is used to print. Contact your sales or service representative.
Error 30722	Tray 1 cannot be used.	Another tray is used to print. Contact your sales or service representative.
Error 30723	Tray 2 cannot be used.	Another tray is used to print. Contact your sales or service representative.
Error 30724	Tray 3 cannot be used.	Another tray is used to print. Contact your sales or service representative.
Error 30725	Tray 4 cannot be used.	Another tray is used to print. Contact your sales or service representative.
Error 30740	The staple tray of SR720 (finisher) cannot be used.	Another tray is used to print. Contact your sales or service representative.
Error 30743	The shift tray cannot be used.	Another tray is used to print. Contact your sales or service representative.
Error 30744	SR720 (finisher) cannot be used.	Another tray is used to print. Contact your sales or service representative.
Error 40711	SR370 (duplex unit) cannot be used.	Press <b>[Job Reset]</b> . Contact your sales or service representative.
Error 40740	The staple tray of SR720 (finisher) cannot be used.	Press <b>[Job Reset]</b> . Contact your sales or service representative.
Error 40744	SR720 (finisher) cannot be used.	Press <b>[Job Reset]</b> . Contact your sales or service representative.
Error Bypass xx	Bypass Tray is out of paper. xx : Paper Size	Load paper of the indicated paper size into the bypass tray.
Error: Finisher SC###	An error with SR720 (finisher) has occurred.	Turn the printer power off and on. If the message appears again, contact your sales or service representative.

Messages	Description	Comments
Finisher In Use Please Wait	SR720 (finisher) is used by the other application.	Wait until the other application finished to use SR720 (finisher).
Form Feeding...	Doing form feed.	Wait for a while.
Load Bypass xx	The bypass tray is out of paper. xx : Paper Size	Load paper of the indicated paper size into the bypass tray.
Load Tray ** xx	There is out of paper. ** : Number Tray xx : Paper Size	Load paper of the indicated paper size into the paper tray.
Load *** XX	There is no paper tray of the indicated. ***: Paper Type XX: Paper Size	Load paper onto the tray of the indicated.
No Files Exist	There is no proof print file.	Specify correct proof print file.⇒ P.77 "Deleting a Proof Print File"
Offline	Printer is offline. The printer cannot accept or print out data.	If you want to put the printer online, press the <b>[Online]</b> .
Printing...	Doing print job.	Wait for a while.
Processing...	Print data is being processed.	Wait for a while.
Processing... Please Wait	The user tries to print the Proof Print data while writing the data to HDD.	Wait until the printer returns to the ready condition.
Ready	The printer is ready for printing.	—
Remove Paper from Duplex Unit	There is still paper in AD370 (duplex unit).	Remove paper from AD370 (duplex unit).
Remove Paper from Staple Tray	There is paper in the stack unit of SR720 (finisher).	Remove paper from the stack unit of SR720 (finisher).  <b>❗ Important</b> <input type="checkbox"/> Remove the paper from the output tray before it becomes full. If you leave paper in the output tray, it can cause a paper misfeed.
Remove Paper Shift Tray	The shift tray of SR720 (finisher) is full.	Remove paper from the SR720 (finisher) tray.  <b>❗ Important</b> <input type="checkbox"/> Remove the paper from the output tray before it becomes full. If you leave paper in the output tray, it can cause a paper misfeed.

Messages	Description	Comments
Remove Paper Standard Tray	The standard output tray is full.	Remove paper from the output tray. <b>Important</b> <input type="checkbox"/> Remove the paper from output tray before it becomes full. If you leave paper in the output tray, it can cause a paper misfeed.
Remove Paper 1Bin Tray	The PT270 (1bin tray) is full.	Remove the paper from the PT270 (1bin tray). <b>Important</b> <input type="checkbox"/> Remove the paper from the output tray before it becomes full. If you leave paper in the tray, it can cause a paper misfeed.
Reset Duplex Unit Correctly	The AD370 (duplex unit) is not set correctly.	Set the AD370 (duplex unit) correctly.
Resetting Job...	Resetting Print job.	Wait for while.
Reset Tray XX Correctly	There is no paper tray, or Tray XX is not set correctly. <b>Note</b> <input type="checkbox"/> This message appears only for the default tray. ⇒ P.67 "Job Control Parameters"	Set the tray correctly.
Setting Changed Cannot Print	The paper feed unit setting has been changed, and the proof print failed.	Configure the paper feed unit correctly, and try again.
Waiting...	Printer is waiting for the next data to print.	Wait for a while.
Warming Up...	The printer is now preparing for printing.	Wait until the printer is warmed up.

**Note**

- If you cannot solve the problem by taking above actions, turn the main power switch off and then back on again. If this does not clear the error message, write down the error message, and contact your sales or service representative.

## Getting Printer Information over the Network

### Printer Current Status

You can check the printer's current status using the "Telnet (mshell)".

#### ❖ mshell

Use status command.

#### 🔍 Reference

For more information, see "Remote Maintenance by Telnet (mshell)" in the "Operating Instructions" of the optional Network Interface Board which in the CD-ROM.

Messages	Description	Resolution
Add Staples	The staple is empty.	Replace the staple refill with a new one.
Add Toner	The printer is out of toner.	Replace a new toner bottle.
Call Service Power Off On	The Service Code or SC number identifies the failure.	Contact your sales or service representative.
Call Service SC_XXX	The Service Code or SC number identifies the failure.	Turn the printer off and on. If the message appears again, contact your sales or service representative.
Close Bridge Unit Cover	The cover of Bridge Unit Type 270 is open.	Close the cover of Bridge Unit Type 270.
Close Finisher Cover	The cover of SR720 (finisher) is open.	Close the cover of SR720 (finisher).
Close Interchange Unit Cover	The Interchange Unit Type 280 cover is open.	Close the interchange unit cover.
Close Right Cover	The right cover of the printer is open.	Close the right cover of the printer.
Close R-Cover at Paper Tray	Lower right cover 1 or 2 is open.	Close lower right cover 1 or 2.
Close Upper Right Cover	The upper right cover is open.	Close the upper right cover.
Dup. Unit In Use Please Wait	AD370 (duplex unit) is used by the other application.	Wait until the other application finished to use AD370 (duplex unit).
Energy Saver 1	In Energy Save Mode level 1.	Press the operation key or send a job from the computer to turn the power on.

Messages	Description	Resolution
Energy Saver 2	In Energy Save Mode level 2.	Press the operation key or send a job from the computer to turn the power on.
Error 30711	AD370 (duplex unit) cannot be used.	Another tray is used to print. Contact your sales or service representative.
Error 30721	PS420 (paper feed unit) cannot be used.	Another tray is used to print. Contact your sales or service representative.
Error 30722	Tray 1 cannot be used.	Another tray is used to print. Contact your sales or service representative.
Error 30723	Tray 2 cannot be used.	Another tray is used to print. Contact your sales or service representative.
Error 30724	Tray 3 cannot be used.	Another tray is used to print. Contact your sales or service representative.
Error 30725	Tray 4 cannot be used.	Another tray is used to print. Contact your sales or service representative.
Error 30740	The staple tray of SR720 (finisher) cannot be used.	Another tray is used to print. Contact your sales or service representative.
Error 30743	The shift tray cannot be used.	Another tray is used to print. Contact your sales or service representative.
Error 30744	SR720 (finisher) cannot be used.	Another tray is used to print. Contact your sales or service representative.
Error 40711	AD370 (duplex unit) cannot be used.	Press <b>[Job Reset]</b> . Contact your sales or service representative.
Error 40740	The staple tray of SR720 (finisher) cannot be used.	Press <b>[Job Reset]</b> . Contact your sales or service representative.
Error 40744	SR720 (finisher) cannot be used.	Press <b>[Job Reset]</b> . Contact your sales or service representative.
Finisher In Use Please Wait	SR720 (finisher) is used by the other application.	Wait until the other application finished to use SR720 (finisher).
Load Bypass xx	Bypass Tray is out of paper. xx : Paper Size	Load paper of the indicated paper size into the bypass tray.



Messages	Description	Resolution
Load Tray ** xx	There is out of paper. ** : Tray Number xx : Paper Size	Load paper of the indicated paper size into the paper tray.
Load *** xx	There is no paper tray of the indicated. *** : Paper Type xx : Paper Size	Load paper onto the tray of the indicated.
Low On Toner	The toner bottle is almost empty.	Prepare a new toner bottle. If the image density is too light, replace the old toner bottle with a new one.
Misfeed:{location} Open Front Cover	There is a misfeed in the printer.	Remove the misfed paper from {location}.
Offline	Printer is offline. The printer cannot accept or print out data.	If you want to put the printer online, press <b>[Online]</b> .
Ready	The printer is ready for printing.	—
Remove Misfeed from Duplex Unit	There is a misfeed in AD370 (duplex unit).	Remove the misfed paper from AD370 (duplex unit).
Remove Misfeed From Finisher	There is a misfeed in SR720 (finisher).	Remove the misfed paper from SR720(finisher).
Remove Paper from Duplex Unit	There is still paper in AD370 (duplex unit).	Remove the paper from AD370 (duplex unit).  <b>Important</b> <input type="checkbox"/> Remove paper from the output tray before it becomes full. If you leave paper in the output tray, it can cause a paper misfeed.
Remove Paper Shift Tray	The shift tray of SR720 (finisher) is full.	Remove paper from the shift tray of SR720 (finisher).  <b>Important</b> <input type="checkbox"/> Remove paper from the output tray before it becomes full. If you leave paper in the tray, it can cause a paper misfeed.

Messages	Description	Resolution
Remove Paper from Staple Tray	There is still paper in the staple tray of SR720 (finisher).	Remove paper from the staple tray of SR720 (finisher).  <b>Important</b> <input type="checkbox"/> Remove paper from the output tray before it becomes full. If you leave paper in the output tray, it can cause a paper misfeed.
Remove Paper Standard Tray	The standard output tray is full.	Remove paper from the standard output tray  <b>Important</b> <input type="checkbox"/> Remove paper from the output tray before it becomes full. If you leave paper in the output tray, it can cause a paper misfeed.
Remove Paper 1Bin Tray	The PT270 (1bin tray) is full.	Remove the paper from the PT270 (1bin tray).  <b>Important</b> <input type="checkbox"/> Remove the paper from the output tray before it becomes full. If you leave paper in the output tray, it can cause a paper misfeed.
Reset Duplex Unit Correctly	AD370 (duplex unit) is not set correctly.	Set AD370 (duplex unit) correctly.
Reset Fusing Unit Correctly	There is no fusing unit, or the fusing unit is not installed properly.	Contact your sales or service representative.
Reset PCU Correctly	There is no Photo Conductor Unit Type 270, or Photo Conductor Unit Type 270 is not installed properly.	Contact your sales or service representative.
Reset Tray XX Correctly	There is no paper tray, or Tray XX is not set correctly.  <b>Note</b> <input type="checkbox"/> This message appears only for the default tray. ⇒ P.67 "Job Control Parameters"	Set the tray correctly.
Warming Up...	The printer is now preparing for printing.	Wait until the printer is warmed up.

## Printer Configuration

You can check the printer configuration using the "mshell".

### ❖ mshell

Use info command.

### 🔍 Reference

For more information on the printer configuration with this method, see the "Operating Instructions" for the optional Network Interface Board which in the CD-ROM.

Item	Description
Input Tray	
No.	ID number of the paper tray
Name	Name of the paper tray* <sup>1</sup>
Page Size	Paper size loaded in the paper tray* <sup>2</sup>
Status	Current status of the paper tray* <sup>3</sup>
Output Tray	
No..	ID number of the output tray
Name	Name of the output tray * <sup>4</sup>
Status	Current status of the output tray * <sup>5</sup>
Emulation	
No.	ID number of the emulation used which the printer
Name	Name of the emulation used which the printer
Version	Version of the emulation
Program	No Entries

















### 📌 Note







- ❑ "\*" (asterisk) is displayed with the current setting.
- ❑ Regarding \*1-<sup>5</sup>, see the attached tables.

❖ \*1 Input Tray: Name

Name	Description
Tray 1	Tray 1
Tray 2	Tray 2
Tray 3	PS400, PS420, PS440 (upside)
Tray 4	PS440 (downside)
Bypass Tray	Bypass Tray

❖ \*2 Input Tray: Page Size

Paper Size	Description
A3(297 x 420)	A3 
B4 JIS(257 x 364)	B4 
A4(210 x 297)	A4 
A4(297 x 210)	A4 
B5 JIS(182 x 257)	B5 
B5 JIS(257 x 182)	B5 
A5(148 x 210)	A5 
A5(210 x 148)	A5 
A6(105 x 148)	A6 
11 x 17	11"×17" 
8 1/2 x 14	8 1/2"×14" 
8 1/2 x 11	8 1/2"×11"  Letter
11 x 8 1/2	8 1/2"×11"  Letter
7 1/4 x 10 1/2	7 1/4" x 10 1/2"  Executive
10 1/2 x 7 1/4	7 1/4" x 10 1/2"  Executive
5 1/2 x 8 1/2	5 1/2" x 8 1/2"  Half Letter
8 1/2 x 5 1/2	5 1/2" x 8 1/2"  Half Letter
8 1/4 x 13	8 1/4" x 13" 
8 1/2 x 13	8 1/2" x 13" 
8 x 13	8" x 13" 
4 1/8 x 9 1/2	Com10 Env.(4.125" x 9.5") 
3 7/8 x 7 1/2	Monarch Env.(3.875" x 7.5") 

Paper Size	Description
C6 Env(114 x 162)	C6 Env.(114 x 162mm) 
C5 Env(162 x 229)	C5 Env.(162 x 229mm) 
DL Env(110 x 220)	DL Env.(110 x 220mm) 
8K(267 x 390)	8K 
16K(195 x 267)	16K 
16K(267 x 195)	16K 
FRE	Custom Paper Size

## ❖ \*3 Input Tray: status

Sstatus	Description
Normal	Normal
NoTray	There is no paper tray.
PaperEnd	There is no paper in the paper tray.

## ❖ \*4 Output Tray: Name

Name	Description
Standard Tray	Standard tray
Internal 1Bin Tray	Output tray (upside)
Finisher Tray	SR720 tray
Shift Unit Tray	Shift tray

## ❖ \*5 Output Tray: status

Status	Description
Normal	Normal
Paper Exist	Paper exists in output tray.

# Printer Doesn't Print

Possible Cause	Solutions
Is the power on?	If not, confirm that the cord is securely plugged into the power outlet and the machine. Turn on the machine power.
Does the <b>On Line</b> indicator stay on?	If not, press <b>[Online]</b> to make it light up.
Does the <b>Error</b> indicator stay red?	Press <b>[Printer]</b> . If not, check the error message on the panel display and take the required action.
Is the paper set?	Load paper into the paper tray.
Is your specified paper size correct?	Set the specified paper in any of the input trays. Adjust the paper size dial to match the size and feed direction of the paper in the paper tray.
Is your specified paper type correct?	Set the specified paper in any of the input trays. Adjust the paper type to use the operation panel.
Can you print a configuration page?	If you cannot print a configuration page, it probably indicates printer malfunction. You should contact your sales or service representative.  If you can print a configuration page but cannot get the printer to print when you issue a print command from your computer, it probably means there is a problem with your computer.  Also keep it in mind that large, complex data might take long time for printer process.
Is the network cable between the machine and your computer connected securely?	Connect the network cable correctly. If there are any connectors or screws, confirm they are fastened securely.
Are you using a correct network cable?	The type of network cable you should use depends on your computer. Be sure to use the correct one. ⇒ P.1 <i>"Connecting the Machine"</i>  If the cable is damaged or worn, replace it with new one.
Did you connect the interface cable after turning on the main switch?	Confirm of connecting the interface cable before turning on the main switch.

Possible Cause	Solutions
If you print using the PostScript driver in a network, data is received by the printer, but is not printed.	<ul style="list-style-type: none"><li data-bbox="485 220 1225 355">❖ <b>Windows 95/98</b> On the <b>[PostScript]</b> tab of the Printer Properties, click <b>[Advanced]</b> and then clear both <b>[Send CTRL+D before job]</b> and <b>[Send CTRL+D after job]</b>.</li><li data-bbox="485 382 1225 517">❖ <b>Windows NT 4.0</b> Open the <b>[Advanced]</b> tab of the Printer Properties. From <b>[PostScript Options]</b>, select <b>[No]</b> for both <b>[Send CTRL-D Before Each job:]</b> and <b>[Send CTRL-D After Each job:]</b>.</li><li data-bbox="485 544 1225 641">❖ <b>Windows 3.1x</b> Click the <b>[PostScript]</b> tab of the Printer Setting dialog box. From <b>[Protocol Options]</b>, select <b>[None]</b>.</li></ul>

Possible Cause	Solutions
<p>If you print using the PostScript driver, printing does not start or is interrupted.</p>	<p>The data is cleared when the Job Timeout period is exceeded.</p> <ul style="list-style-type: none"> <li>❖ <b>Windows 95/98</b> Set a longer [Job Timeout] period with the [PostScript] tab of the Printer Properties.</li> <li>❖ <b>Windows NT 4.0</b> Set a longer [Job Timeout] period with the [Device Settings] tab of the Printer Properties.</li> <li>❖ <b>Windows 3.1x</b> Set a longer [Job Timeout] period with the [PostScript] tab of the Printer Setting dialog box.</li> </ul>
	<p>A PostScript error might occur if there is not enough memory in the printer, or there are errors in the print data sent to the printer.</p> <ul style="list-style-type: none"> <li>• Print a configuration page to configure the memory size and confirm the memory size is max or not.</li> <li>• If the memory size is max, increasing the memory may solve this problem. You should contact your sales or service representative. For more information on the memory, see P.79 "Memory Capacity and Printer Function".</li> </ul>
	<p>The print job might be reset. Do the following.</p> <ul style="list-style-type: none"> <li>• Confirm that you have selected the correct printer driver. Try printing again.</li> <li>• Set a longer Wait Timeout.</li> </ul> <ul style="list-style-type: none"> <li>❖ <b>Windows 95/98</b> Set a longer [Wait Timeout] period with the [PostScript] tab of the Printer Properties.</li> <li>❖ <b>Windows NT 4.0</b> Set a longer [Wait Timeout] period with the [Device Settings] tab of the Printer Properties.</li> <li>❖ <b>Windows 3.1x</b> Set a longer [Wait Timeout] period with the [PostScript] tab of the Printer Setting dialog box.</li> <li>❖ <b>Macintosh</b> You can specify a longer [I/O Timeout] period on the printer's operation panel. ⇒ P.61 "Using the Operation Panel"</li> </ul>



Possible Cause	Solutions
Is the <b>Data In</b> indicator blinking or lit after starting the print job, when using the PCL printer?	<p>If not, the data is not being sent to the printer, or the printer may be resetting the print job because there was a long delay in receiving the data from the computer.</p> <ul style="list-style-type: none"> <li>❖ <b>If the printer is using "I/O Timeout"</b> Increase the value of the "I/O Timeout" setting of the "System" menu of the "Job Control". ⇒ P.61 <i>"Using the Operation Panel"</i></li> <li>❖ <b>If your machine is connected to the computer using the parallel cable</b> Confirm that the printer port settings are correct. For a parallel port connection, port LPT1 or LPT2 should be set. For more information on the printer port settings, see the Note after this table.</li> <li>❖ <b>Network Connection</b> Contact your network administrator.</li> </ul>

### Note

- ❑ The following procedure describes the printer port settings.
  - **Windows 95/98**
    - ① Click **[Start]**, point to **[Settings]**, and then click **[Printers]**.
    - ② Click the icon of the printer. Next, on the **[File]** menu, click **[Properties]**.
    - ③ Click the **[Details]** tab.
    - ④ Check the **[Print to the following port:]** list to confirm the correct port is selected.
  - **Windows NT 4.0**
    - ① Click **[Start]**, point to **[Settings]**, and then click **[Printers]**.
    - ② Click the icon of the printer. Next, on the **[File]** menu, click **[Properties]**.
    - ③ Click the **[Port]** tab.
    - ④ Confirm that the correct port is selected.
  - **Windows 3.1x**
    - ① On **[Control Panel]**, double-click the **[Printers]** icon.
    - ② Confirm that this printer is specified as the default printer.
    - ③ Click **[Connect]**.
    - ④ Check the **[Ports]** list to confirm the correct port is selected.
  - **Macintosh**
    - ① Click **[Apple Menu]**, point to **[Control Panels]**, and then select **[Apple Talk]**.
    - ② Confirm that **[Ethernet]** is selected in the **[connect via:]** list.

## Other Printing Problems

Problem	Action
It takes a long time for the printer to start printing.	The machine might be in Energy Saver mode or Low Power mode, which requires more time for warming up and resuming the print job. If you can't wait, change the settings of Low Power, Shift Time and Low Power Timer.
It takes too much time to complete the print job.	The data is so large or complex that it takes time to process it. If the <b>Data In</b> indicator is blinking, the data processing is being done. Just wait until it is finished.
Windows 95/98, NT 4.0 : The computer doesn't recognize the installed printer options.	If the connection to the printer is not bi-directional, the computer does not recognize the installed printer options. Setting of the options might not be specified correctly. In this case, specify which options you have installed using the printer driver.   <b>Reference</b> For more information on the setting options with installing the printer driver. => P.20 "Installing the PCL 6/5e Printer Driver" , P.23 "Installing the PostScript Printer Driver"
Windows 3.1x : The print job can't be sent.	The memory buffer might be full. Remove the check mark from the <b>[Use Print Manager]</b> check box, or make the time out setting longer.

# 7. Using the Operation Panel

This section describes the information on adjusting the printer settings using the System Settings and the Printer Features menus.

## **Note**

- After using **[User Tools]**, be sure to return to Printer mode.
- The settings are not canceled even if the operation switch is turned off or the **[Escape]** key is pressed.

## **Reference**

For more information on specifying the network system, see P.11 *“Configuring the Printer for the Network with the Operation Panel”*.

For information of the Copy Features, Fax Features and Specify the System Settings, see the "Copy Reference", the "Fax Reference" and the "System Settings".

# Adjusting Printer Features

---

## Printer Features Menu

---

There are 5 menu items in the “Printer Features” menu.

- Proof Print
- Job Control
- Network Setup
- Maintenance
- List Print

You can select functions in following table.

Category	Function Menu	
Proof Print ⇒ P.66 “Proof Print Menu”	Print File	
	Delete File	
	Show Error Log	
Job Control ⇒ P.67 “Job Control Menu”	Paper Input	Tray Priority
		Tray Locking
		Bypass Size
	Print Quality	Edge Smoothing
		Resolution
		Toner Saving
	System	Print PS Errors
		I/O Timeout
		I/O Buffer
	PCL Menu	Orientation
		Form Lines
		Font Source
		Font Number
		Point Size
		Font Pitch
Symbol Set		
Network Setup ⇒ P.71 “Network Setup Menu”	IP Address	
	Subnet Mask	
	Gateway Address	
	Access Control	
	Access Mask	
	Network Boot	
	Frame Type(NW)	
	ActiveProtocols	
Maintenance ⇒ P.72 “Maintenance Menu”	Restart Printer	
	Menu Reset	
	Hex Dump	
List Print ⇒ P.73 “List Print Menu”	Config. Page	
	Menu List	
	PCL Font List	
	PS Font List	
	Disk Directory	

## Accessing the Main Menu

Confirm that the printer is offline. If not, take the printer offline.

Press **[User Tools]** and press **[4]** on the number key to display the “Main Menu” on the panel display.

The “Main Menu” has the following five menus, which can be displayed one by one using **[↓]** or **[↑]**.

- Proof Print
- Job Control
- Network Setup
- Maintenance
- List Print

### **Note**

- [↓]**: Press to go to the next page.
- [↑]**: Press to go back to the previous page.
- After making the printer's settings, be sure to return to the previous menu by pressing **[Escape]**.
- After making the printer's settings, press **[Online]** to return to the ready condition.
- The revised settings are not canceled even if the machine power is turned off.

# Making Printer Settings with the Operation Panel

**1** Press **[User Tools]**.

**2** Press **[4]** on the number keys.

**3** Search for the desired menu with **[↓]** or **[↑]**.

The desired menu appears.

**4** Press **[Enter #]**.

**5** Search for the desired menu with **[↓]** or **[↑]**.

The desired menu or parameter appears.

 **Note**

“✖” shown in front of a item indicates that the item is currently selected.

**6** Press **[Enter #]**.

The specified item appears.

**7** If necessary, repeat steps **5** and **6** until you complete the desired settings.

 **Note**

**[Escape]**: Press to return to the previous menu. If you press this key before pressing **[Enter #]**, the adjusted data is canceled.

## Proof Print Menu

There are 3 menus in the “Proof Print” menu.

- Print File
- Delete File
- Show Error Log

### Reference

For more information on “Proof Print”, see P.76 “Using the Proof Print”.

---

## Proof Print Parameters

---

### ❖ Proof Print

Menu	Description
Print File	Select a proof print file and print it.
Delete File	Select a proof print file and delete it.
Show Error Log	Show the error log in the proof print job.





# Job Control Menu

There are 4 menus in the “Job Control” menu.



- Paper Input
- Print Quality
- System
- PCL Menu

## Job Control Parameters



### ❖ Paper Input

Menu	Description
Tray Priority	<p>You can specify the default tray. The tray selection specified with the printer driver overrides the one specified here. In DOS printing, the tray specified here is used, when no tray is specified for a print job.</p> <p>Tray1, Tray2, Tray3, Tray4</p> <p> <b>Note</b></p> <ul style="list-style-type: none"> <li><input type="checkbox"/> Default: <i>Tray1</i></li> <li><input type="checkbox"/> Only the installed trays appear on the panel display.</li> <li><input type="checkbox"/> It is recommended that you load paper having the size and direction you frequently use in the tray selected with the “Tray Priority”.</li> </ul>
Tray Locking	<p>If you use several different kinds of paper, you can lock a tray to prevent printing on wrong paper. When you want to use the locked tray, specify it using the printer driver.</p> <p>None, Tray1, Tray2, Tray3, Tray4</p> <p> <b>Note</b></p> <ul style="list-style-type: none"> <li><input type="checkbox"/> Default: <i>None</i></li> <li><input type="checkbox"/> Only the installed trays appear on the panel display.</li> <li><input type="checkbox"/> You cannot lock multiple trays at once.</li> <li><input type="checkbox"/> When a locked tray is specified using the printer driver, the printer does not search for any other tray.</li> </ul>
Bypass Tray	<p>You can specify the paper size for the bypass tray.</p> <p> <b>Note</b></p> <ul style="list-style-type: none"> <li><input type="checkbox"/> Default: <i>A4 (Metric version), 8 1/2" × 11" (Inch version)</i></li> <li><input type="checkbox"/> width: 90mm (3.53") to 297mm (11")</li> <li><input type="checkbox"/> length: 148mm (5.83") to 432mm (17")</li> </ul>

## ❖ Print Quality

Menu	Description
Edge Smoothing	<p>You can specify whether the Edge Smoothing feature is enabled.</p> <ul style="list-style-type: none"> <li>• On</li> <li>• Off</li> </ul> <p> <b>Note</b></p> <ul style="list-style-type: none"> <li><input type="checkbox"/> Default: <i>On</i></li> <li><input type="checkbox"/> If "Edge Smoothing" is "On", "Toner Saving" is ignored even if it is "On".</li> </ul>
Resolution	<p>You can specify the print resolution in dots per inch.</p> <ul style="list-style-type: none"> <li>• 600 dpi (PCL 5e, PCL 6, PS)</li> <li>• 300 dpi (PCL 5e, PS)</li> </ul> <p> <b>Note</b></p> <ul style="list-style-type: none"> <li><input type="checkbox"/> Default: <i>600 dpi</i></li> <li><input type="checkbox"/> The resolution specified with the printer driver overrides the one specified here.</li> </ul>
Toner Saving	<p>You can specify whether or not the Toner Saving feature is enabled.</p> <ul style="list-style-type: none"> <li>• Off</li> <li>• On</li> </ul> <p> <b>Note</b></p> <ul style="list-style-type: none"> <li><input type="checkbox"/> Default: <i>Off</i></li> <li><input type="checkbox"/> If "Edge Smoothing" is "On", "Toner Saving" is ignored even if it is "On".</li> </ul>





## ❖ System<sup>1/2</sup>

Menu	Description
Print PS Errors	<p>You can specify whether the PS error sheet should be printed out.</p> <ul style="list-style-type: none"> <li>• Off</li> <li>• On</li> </ul> <p> <b>Note</b></p> <ul style="list-style-type: none"> <li><input type="checkbox"/> Default: <i>Off</i></li> </ul>
I/O Timeout	<p>You can specify how many seconds the printer should wait before ending a print job. If data from other ports often appear in the middle of your print job, you should increase the timeout value.</p> <p>15 seconds, 30 seconds, 60 seconds, 180 seconds, 300 seconds</p> <p> <b>Note</b></p> <ul style="list-style-type: none"> <li><input type="checkbox"/> Default: <i>30 seconds</i></li> </ul>



❖ System<sup>2</sup>/<sub>2</sub>

Menu	Description
I/O Buffer	<p>You can specify the size of the I/O Buffer. Normally it is not necessary to change this setting.</p> <p>16KB, 32KB, 64KB, 128KB, 256KB, 512 KB,</p> <p> <b>Note</b></p> <p><input type="checkbox"/> Default: 32KB</p>

❖ PCL Menu <sup>1</sup>/<sub>2</sub>

Menu	Description
Orientation	<p>You can specify the page orientation.</p> <p>The tray selection specified with the printer driver overrides the one specified here.</p> <ul style="list-style-type: none"> <li>• Portrait</li> <li>• Landscape</li> </ul> <p> <b>Note</b></p> <p><input type="checkbox"/> Default: <i>Portrait</i></p>
Form Lines	<p>You can specify the number of lines per page.</p> <p>5-128</p> <p> <b>Note</b></p> <p><input type="checkbox"/> Default: 64 (Metric version), 60 (Inch version)</p>
Font Source	<p>You can specify the location of the default font.</p> <ul style="list-style-type: none"> <li>• Internal</li> <li>• Download</li> </ul> <p> <b>Note</b></p> <p><input type="checkbox"/> Default: <i>Internal</i></p> <p><input type="checkbox"/> When you select "Download", you can select only downloaded fonts on the RAM.</p>
Font Number	<p>You can specify the ID for the default font you want to use.</p> <ul style="list-style-type: none"> <li>• 1 to 52 (for Internal)</li> <li>• 1 to N (for Download source)</li> </ul> <p> <b>Note</b></p> <p><input type="checkbox"/> Default: 0</p> <p><input type="checkbox"/> "N" depends on how many fonts you have downloaded.</p>

## ❖ PCL Menu 2/2









Menu	Description
Point Size	<p>You can specify the value for the point size you want to use for the selected font.</p> <p>4.00 to 999.75 by 0.25</p> <p> <b>Note</b></p> <p><input type="checkbox"/> Default: <i>12.00</i></p> <p><input type="checkbox"/> This setting is effective only for a variable-space font.</p>
Font Pitch	<p>You can specify the number of characters per inch you want to use for the selected font.</p> <p>0.44 to 99.99 by 0.01</p> <p> <b>Note</b></p> <p><input type="checkbox"/> Default: <i>10.00</i></p> <p><input type="checkbox"/> This setting is effective only for a fixed-space font.</p>
Symbol Set	<p>You can specify the set of print characters for the selected font. The available options are as follows.</p> <p>Roman-8, Win L1, Win L2, Win L5, Win 3.0, Legal, ISO L1, ISO L2, ISO L5, ISO 4, ISO 6, ISO 11, ISO 15, ISO 17, ISO 21, ISO 60, ISO 69, PC-8, PC-850, PC-852, PC-8 D/N, PC8-TK, VN Math, VN US, VN Intl, MS Publ, Pifont, Desktop, Math-8, PS Text, PS Math</p> <p> <b>Note</b></p> <p><input type="checkbox"/> Default: <i>Roman-8</i></p>

# Network Setup Menu

## Reference

For more information on “Network Setup”, see P.11 “Configuring the Printer for the Network with the Operation Panel”.

## Network Setup

Menu	Description
IP Address	You can specify the IP Address.  <b>Note</b> <input type="checkbox"/> Default: <i>All zero</i>
Subnet Mask	You can specify the Subnet Mask.  <b>Note</b> <input type="checkbox"/> Default: <i>All zero</i>
Gateway Address	You can specify the Gateway Address.  <b>Note</b> <input type="checkbox"/> Default: <i>All zero</i>
Access Control	You can specify the Access Control Address.  <b>Note</b> <input type="checkbox"/> Default: <i>All zero</i>
Access Mask	You can specify the Access Mask.  <b>Note</b> <input type="checkbox"/> Default: <i>All zero</i>
Network Boot	You can specify the Network Boot of TCP/IP. None, RARP + TFTP, BOOTP, RARP & BOOTP, DHCP, ARP + PING, ARP & RARP, ARP & BOOTP, ARP&RARP&BOOTP  <b>Note</b> <input type="checkbox"/> Default: <i>None</i>
Frame Type(NW)	You can specify the Fream Type of Netware. Auto, Ethernet II, Ethernet 802.3, Ethernet 802.2, Ethernet SNAP  <b>Note</b> <input type="checkbox"/> Default: <i>Auto</i>
ActiveProtocols	You can specify the Active Protocols. All Active, None, TCP/IP Only, NetWare Only, TCP/IP & NetW, ATalk Only, TCP/IP & ATalk, NetWare & ATalk, NetBEUI & ATalk, TCP & NW & ATK, NetBEUI only, TCP/IP & NB, NetBEUI & NetW, TCP & NB & NW, NetBEUI & ATalk, TCP & NB & ATK, NB & NW & ATalk  <b>Note</b> <input type="checkbox"/> Default: <i>All Active</i>

# Maintenance Menu

There are 3 menus in the "Maintenance" Menu.

- Restart Printer
- Menu Reset
- Hex Dump

---

## Maintenance Parameters

---

### ❖ Restart Printer

Menu	Description
Restart Printer	You can restart the printer.

### ❖ Menu Reset

Menu	Description
Menu Reset	You can reset the menu settings to the factory default except "I/O Buffer" and "Network Setup" settings.

### ❖ Hex Dump

Menu	Description
Hex Dump	<p>You can choose to print the Hex Dump or not. With this feature "On", all data sent to the printer is printed in hexadecimal character representation.</p> <ul style="list-style-type: none"><li>• On</li><li>• Off</li></ul> <p> <b>Note</b></p> <p><input type="checkbox"/> Default: <i>Off</i></p>

7

# List Print Menu

There are 5 menus in the “List Print” Menu.

- Config. Page
- Menu List
- PCL Font List
- PS Font List
- Disk Directory

---

## List Print Parameters

---

### ❖ List Print

Menu	Description
Config. Page	You can print the current configuration of the printer. For more information on printing a configuration page, see P.75 “Printer Condition”.
Menu List	You can print the Menu List which shows the function menu of this printer.
PCL Font List	You can print a list of the installed PCL font.
PS Font List	You can print a list of the installed PS font.
Disk Directory	You can print a list of the HDD directory.

# Specifying the Custom Paper Size for the Bypass Tray

- 1 Press [User Tools].
- 2 Press [4] on the number keys.
- 3 Press [↓] or [↑] until “Job Control” appears, and then press [Enter #].

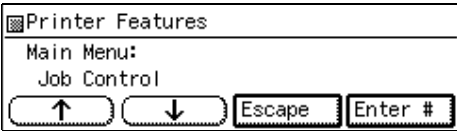

- 4 Press [↓] or [↑] until “Paper Input” appears, and then press [Enter #].

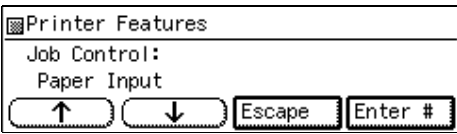

- 5 Press [↓] or [↑] until “Bypass Size” appears, and then press [Enter #].

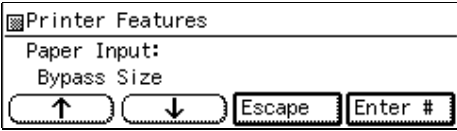

- 6 Specifying the standard size.
  - 1 After confirming that “Standard Size” is displayed, press [Enter #].

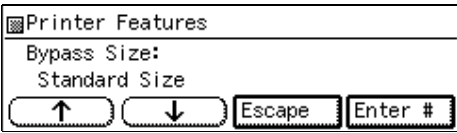

- 2 Press [↓] or [↑] until “Custom Size” is displayed, and then press [Enter #].

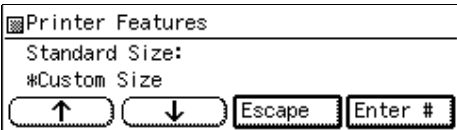

- 7 Specify the Custom Size.

- 1 Press [↓] or [↑] until “Custom Size” is displayed, press [Enter #].

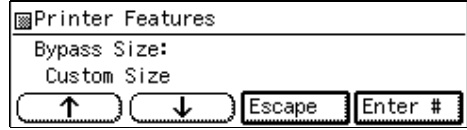

- 2 Press [↑] or [↓] to set the vertical value, and then press [Enter #].

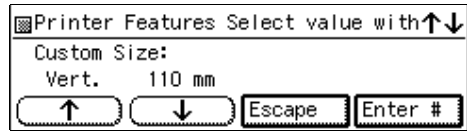

**Note**

- The vertical size and horizontal size are described as follow.

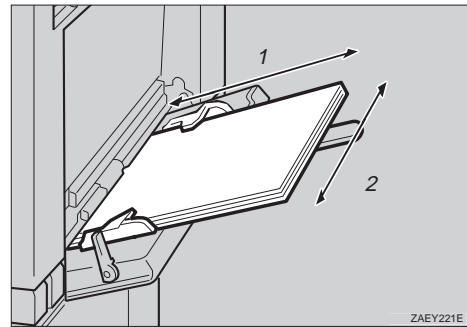

1. Horizontal size

2. Vertical size

- 3 Press [↑] or [↓] to set the horizontal value, and then press [Enter #].

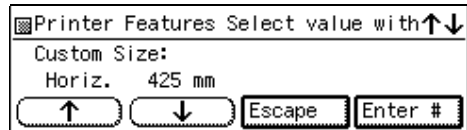



# Printer Condition

We recommend that you print the configuration page and check its settings, before changing settings of your machine.

The following example describes how to print a Configuration Page.

- 1** Press **[User Tools]**.
- 2** Press **[4]** on the number keys.
- 3** Press **[↓]** or **[↑]** until “List Print” appears, and then press **[Enter #]**.

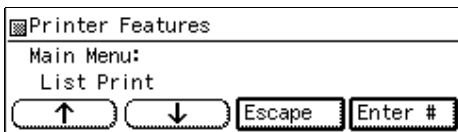

The following message appears on the panel display.

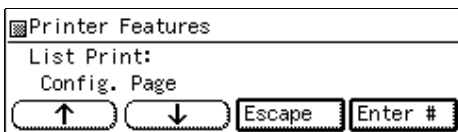

- 4** After confirming that, “Config. Page” on display, press **[Enter #]**.

### Note

- You can specify the Print List items on the panel display.

The following message appears on the panel display.

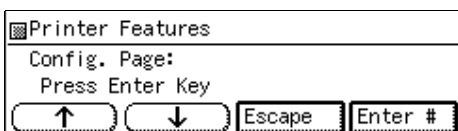

- 5** Press **[Enter #]**.

This starts printing the configuration page.

# Printing with the Operation Panel

## Using the Proof Print

Use this function to print only one printing of a multiple print job. The other printings are saved on the optional hard disk. The saved job can be printed from the machine's operation panel.

### Limitation

- ❑ To use this function, the optional hard disk must be installed.

### Note

- ❑ If the application has a collate option, confirm that it is not selected before sending a print job. By default, proof print jobs are automatically collated by the printer driver. If the collate option is selected from the application print dialog box, more printings than intended may be printed.
- ❑ You can identify the file you want to print by the User IDs and the time when the job was stored.
- ❑ The actual number of pages the printer can save depends on the contents of the print images. As an example, the printer can save up to 30 jobs or 2,000 pages. It depends on the data volume.
- ❑ If the first printing of the proof print file is not what you expected and you do not want to print the remaining printings, delete the proof print file using the operation panel. If you print the remaining printings of the proof print file, the job in the printer is deleted automatically.

## Printing a Proof Print File

- 1 Press the **[User Tools]** key of the machine's operation panel.

- 2 Press **[4]** on the number keys.

- 3 After confirming that "Proof Print" is displayed, press **[Enter #]**.

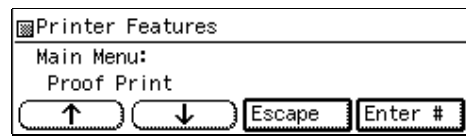

- 4 After confirming that "Print File" is displayed, press **[Enter #]**.

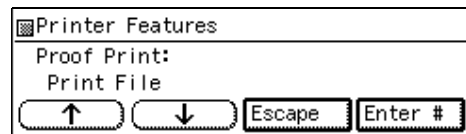

- 5 Press **[↓]** or **[↑]** to display a file you want to print, and then press **[Enter #]**.

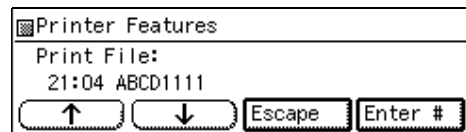

The following message appears on the panel display.

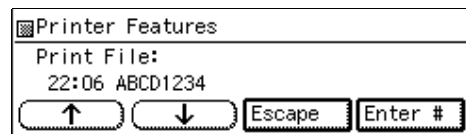

- 6 Press **[↑]** or **[↓]** to set the number of copy printings.

### Note

- ❑ You can set the number up to 999.

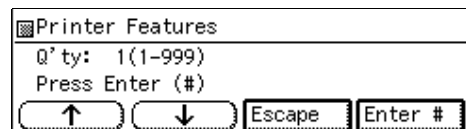

- 7 Press **[Enter #]**.

## Deleting a Proof Print File

If the printed document is not what you expected, you can delete the proof print file. You can then revise it and print again until the settings become OK.

- 1** Press the **[User Tools]** key of the machine's operation panel.
- 2** Press **[4]** on the number keys.
- 3** After confirming that "Proof Print" is on the display, press **[Enter #]**.

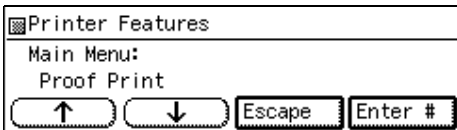

- 4** Press **[↓]** or **[↑]** until "Delete File" appears, and then press **[Enter #]**.

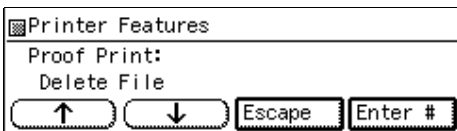

- 5** Press **[↓]** or **[↑]** to display the file you want to delete, and then press **[Enter #]**.

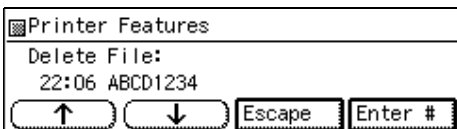

The following message appears on the panel display.

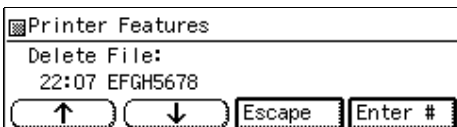

- 6** Press **[Enter #]**.

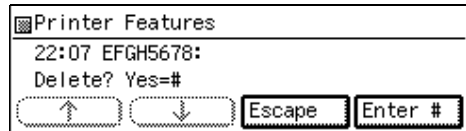

- 7** Press **[Enter #]**.

This starts deleting a proof print file after the following message appears on the panel display.

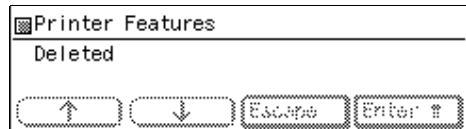

## Checking the Error Log

- 1** Press the **[User Tools]** key of the machine's operation panel.
- 2** Press **[4]** on the number keys.
- 3** After confirming that "Proof Print" is displayed, press **[Enter #]**.

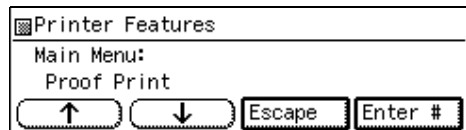

- 4** Press **[↓]** or **[↑]** until "Show Error Log" appears, and then press **[Enter #]**.

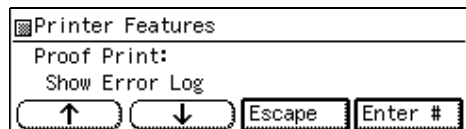

The following message appears on the panel display.

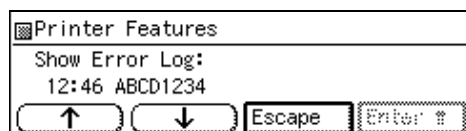



## Memory Capacity and Printer Function

The following table shows the typical memory requirements for each printer function.

 **Note**

- Memory requirements depend on the complexity of the print data and the printing environment.

Functions	Required Options
Collating	Printer Feature Expander Type 185 or Printer Hard Disk Type 185
Stapling	SR720 (finisher)
Duplex Printing	Printer Feature Expander Type 185, AD370 (duplex unit)
Proof Printing	Printer Hard Disk Type 185

## Moving and Transporting the Printer

### **CAUTION:**

- *When lifting the machine, use the grips on both sides of the machine. If you drop the machine, it could break or cause an injury.*
- *When you move the machine, remember to unplug the power cord from the outlet. When you pull the plug out of the socket, hold it by the plug. If the cord is pulled out of the socket abruptly, it could become damaged. Damaged plugs or cords can cause an electrical or fire hazard.*



When transporting paper, repack it with its original packing materials.

### **Important**

- Be sure to disconnect all cables from the printer before transporting it.
- The printer is a precision piece of machinery. Take care to avoid damage during shipment.

# Specifications

This section contains the electrical and hardware specifications for the printer, including the information on the options.

Component	Specification
Resolution	600dpi ; PCL 5e, PCL 6, PostScript 3 300dpi ; PCL 5e, PostScript 3
Printing Speed	22/27 <sup>*1</sup> pages per minute (A4  , 8 1/2" × 11"  )
Parallel Interface	Standard 36-pin printer cable and a parallel port on the host computer. IEEE1284B  <b>Note</b> <input type="checkbox"/> Do not use a parallel cable that is longer than 3 meters (10 feet).
Printer Language	PCL 5e , PCL 6, Post Script 3(option)
Fonts	<b>PCL 5e, PCL 6</b> 35 Intellifonts, 10 TrueType fonts, and 1 Bitmap font Font Manager available. <b>PostScript</b> 136 Adobe Type 1 fonts
Memory	<b>Standard : 16MB</b> <b>Optional Printer Feature Expander Type 185: Up to 80MB</b>
Hard Disk (option)	<b>Storage capacity :approx. 1.6GB</b>
Operation System Supported by this printer	Windows 95/98 Windows NT 4.0 Windows 3.1x Macintosh 7.1 (required the optional PostScript 3 and Network Interface Board Type 185)
Network (option)	<b>Topology :</b> Ethernet 10BASE-T/100BASE-TX <b>Protocol :</b> TCP/IP, IPX/SPX, NetBEUI, AppleTalk
Network Cable (option)	10BASE-T/100BASE-TX shielded twisted-pair (STP, Category/Type5) cable.

\*1 Printing Speed depends on using machine.

# INDEX

---

10BASE-T/100BASE-TX, 1

## A

---

Access Control Address, 11, 15  
Access Control Mask, 11, 15  
ActiveProtocols, 11  
Auto Run, 18

## C

---

Config. Page, 73

## D

---

Data In Indicator, 8  
Delete File, 66

## E

---

Energy Saver key, 8  
Error Indicator, 8  
Error indicator, 56  
Error Messages, 45

## F

---

Frame Type NetWare, 11  
Function keys, 8

## G

---

Gateway Address, 11, 15

## H

---

Hex Dump, 72

## I

---

IP Address, 11

## J

---

Job Control, 67  
FormFeed key, 10  
Job Reset key, 10

## L

---

List Print, 73

## M

---

Macintosh, 40, 44  
    *plugin File, uninstalling, 32*  
    *setting up options, 28*  
Maintenance, 72  
memory, 79  
menu, 64  
Menu key, 64  
Menu List, 73  
Menu Reset, 72

## N

---

Network Boot, 11  
Network Connections, 2  
Network Interface Board 185, 3  
Network Setup, 71  
Number keys, 8

## O

---

Online and Offline, 10  
On Line Indicator, 8  
On Line indicator, 56  
On Line key, 56, 64  
Online key, 10  
Operational Panel, 8  
Operation Switch, 8  
options, setting up  
    *Macintosh, 28*

## P

---

PageMaker 6.0 or 6.5, 26  
Panel Display, 8, 9  
Paper Input, 67  
Parallel Cable, 2, 3  
Parallel Port, 1  
PCL 5e, 7, 33  
    *Windows 3.1x, uninstalling, 30*  
    *Windows 95/98, uninstalling, 29*  
    *Windows NT 4.0, uninstalling, 29*  
PCL 6, 7, 33  
    *Windows 3.1x, uninstalling, 30*  
    *Windows 95/98, uninstalling, 29*  
    *Windows NT 4.0, uninstalling, 29*  
PCL 6/5e  
    *Windows 3.1x - Install, 21*  
    *Windows 95/98 - Install, 20*  
    *Windows NT 4.0 - Install, 20*



PostScript  
    *Windows NT 4.0 - Install*, 23  
PCL Font List, 73  
PCL Menu, 67  
PostScript, 37  
    *Windows 3.1x - Install*, 24  
    *Windows 95/98, uninstalling*, 31  
    *Windows 95/98 - Install*, 23  
    *Windows NT 4.0, uninstalling*, 31  
PostScript Printer Driver  
    *Macintosh, uninstalling*, 32  
    *Windows 3.1x - Uninstall*, 32  
PostScript  
    *Macintosh - Install*, 27  
PPD, 28  
Printer Driver, 20, 21, 23, 24  
printer driver, 6  
Printer Features, 62  
Print File, 66  
Printing Problems, 60  
Print Quality, 67  
Proof Print, 66, 76  
PS Font List, 73

## R

---

Restart Printer, 72

## S

---

Scroll key, 8  
Show Error Log, 66  
Status Messages, 45  
Subnet Mask, 11, 15  
System, 67

## T

---

Troubleshooting, 45

## U

---

User Tools key, 8

## W

---

Windows 3.1x, 35, 39, 43  
    *PCL 5e, uninstalling*, 30  
    *PCL 6, uninstalling*, 30  
Windows 95/98, 33, 37, 42  
    *PCL 5e, uninstalling*, 29  
    *PCL 6, uninstalling*, 29  
    *PostScript, uninstalling*, 31





Declaration of Conformity

“The Product complies with the requirements of the EMC Directive 89/336/EEC and the Low Voltage Directive 73/23/EEC.”



**Caution (in case of 100BaseTX environment):**

Properly shielded and grounded cables (STP) and connectors must be used for connections to host computer (and/or peripheral) in order to meet EMC Directive 89/336/EEC emission limits.





**PRINTER Controller Type 270 OPERATING INSTRUCTIONS**

